

Social Care Health & Housing Chart March 11

Social Care Health and Housing

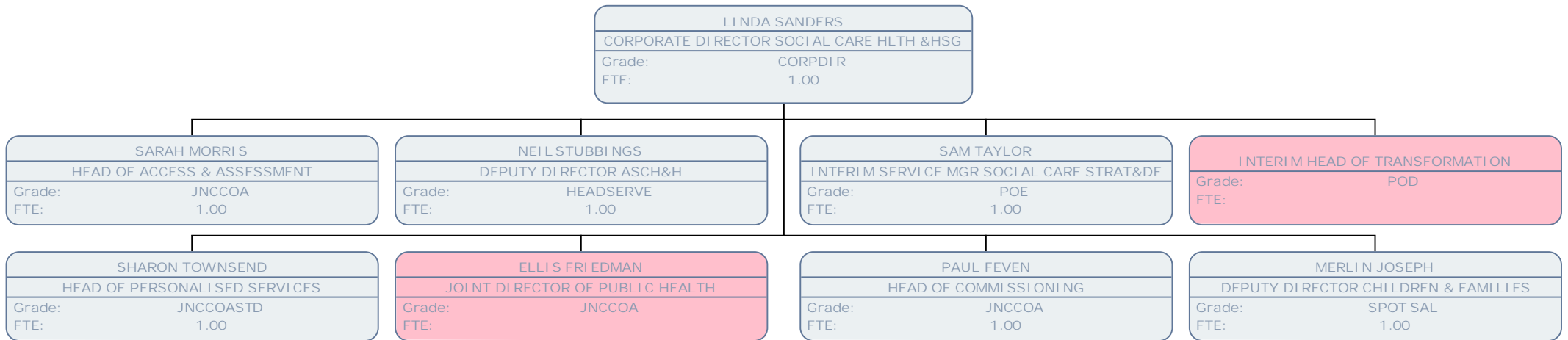

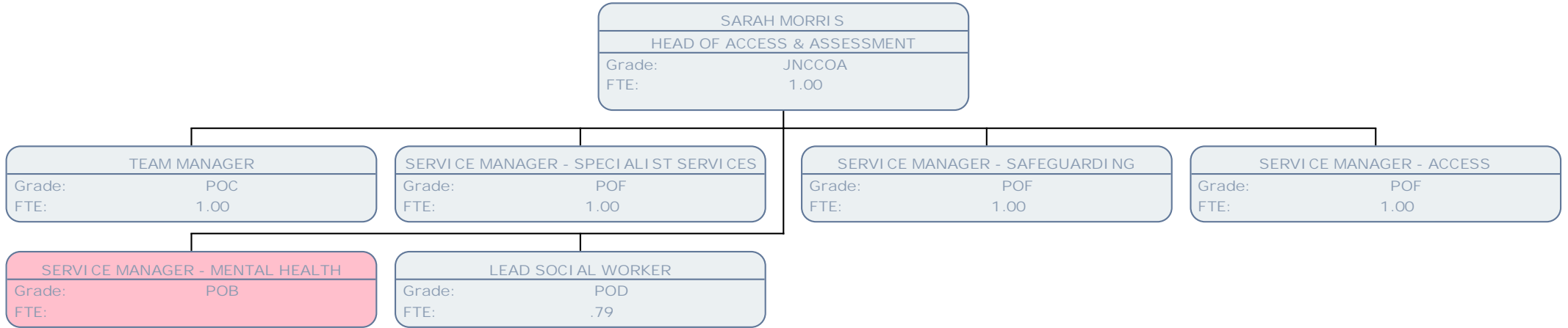

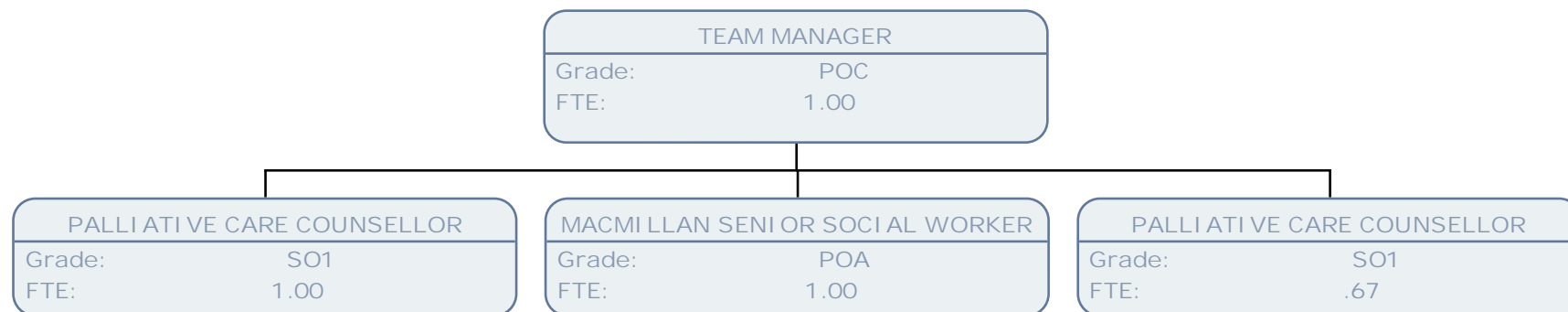

MACMILLAN SENIOR SOCIAL WORKER	
Grade:	POA
FTE:	1.00

MACMILLAN SOCIAL WORK ASSISTANT	
Grade:	SCALE 5
FTE:	.79

MACMILLAN SOCIAL WORK ASSISTANT	
Grade:	SCALE 5
FTE:	.21



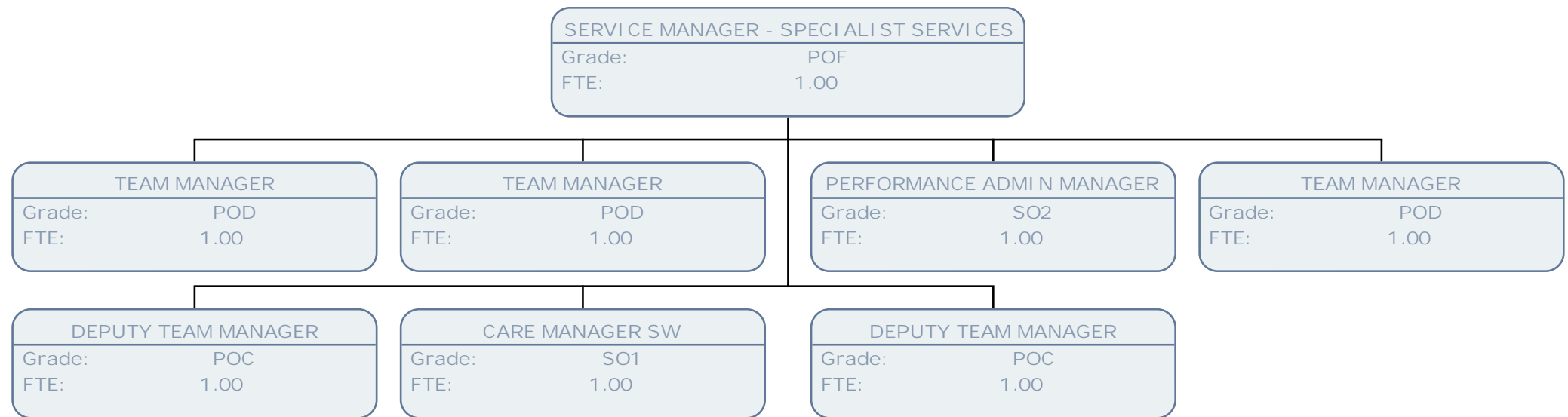

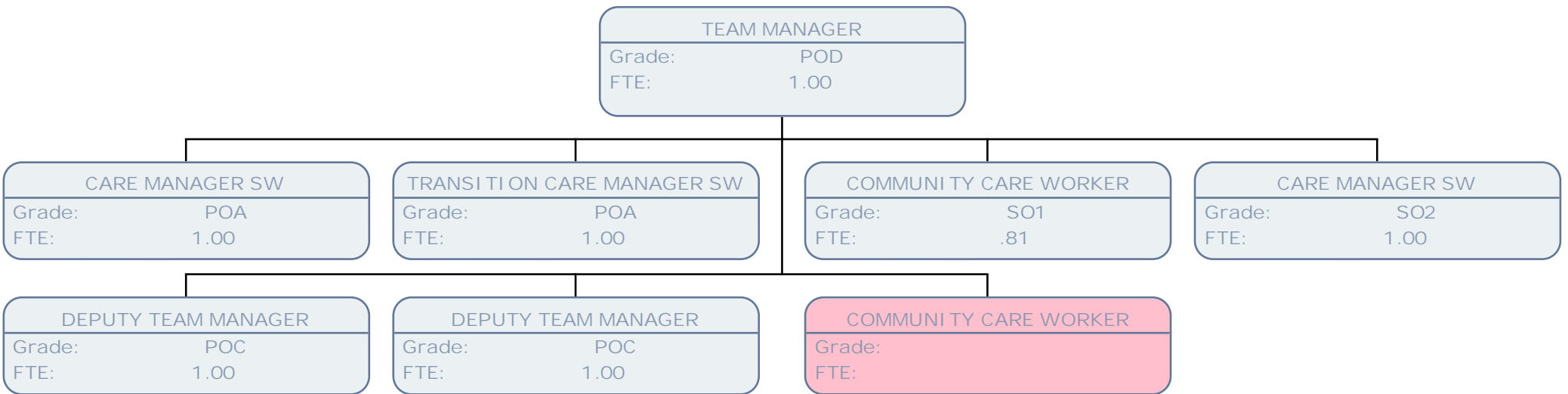

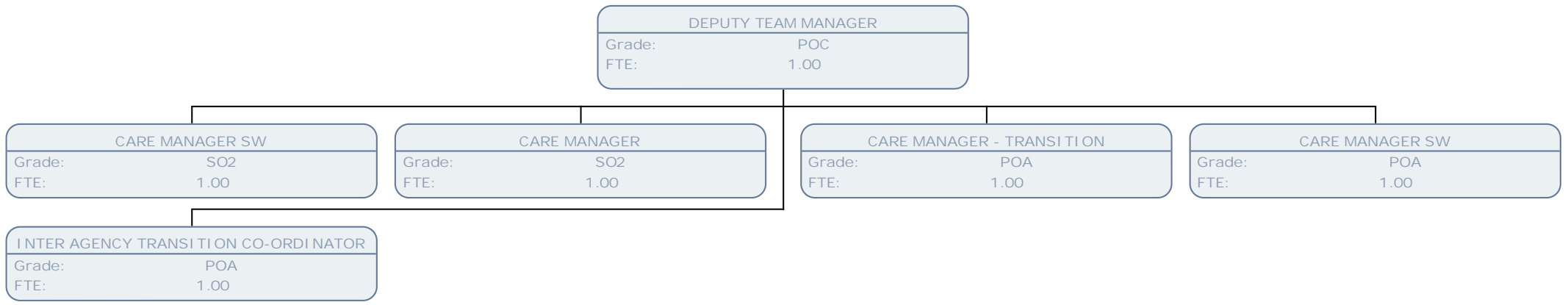

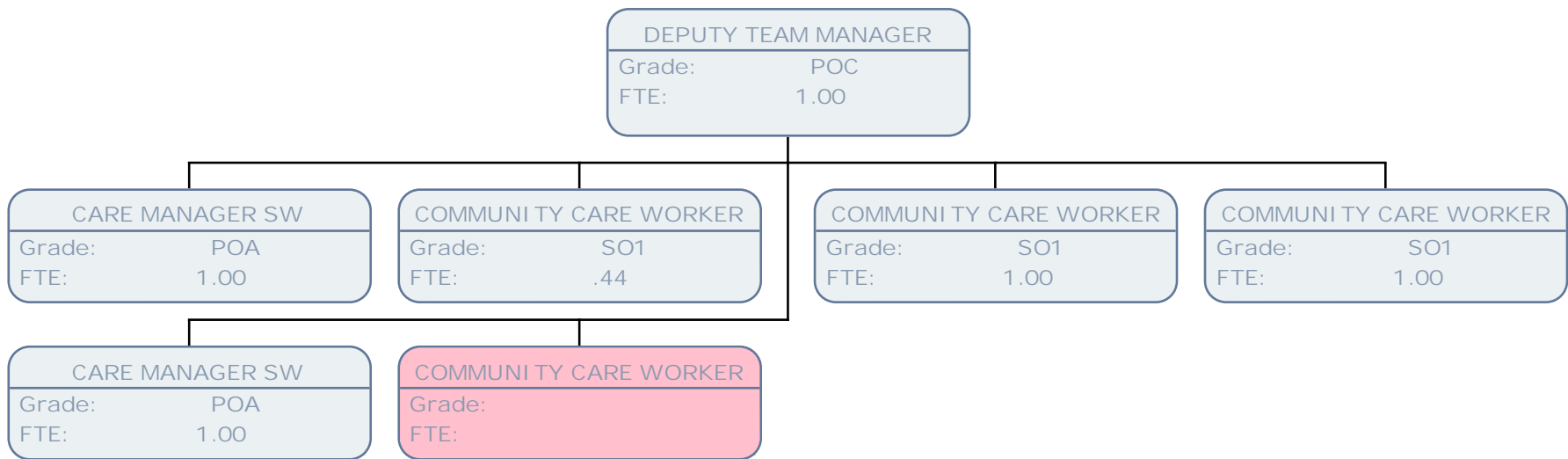

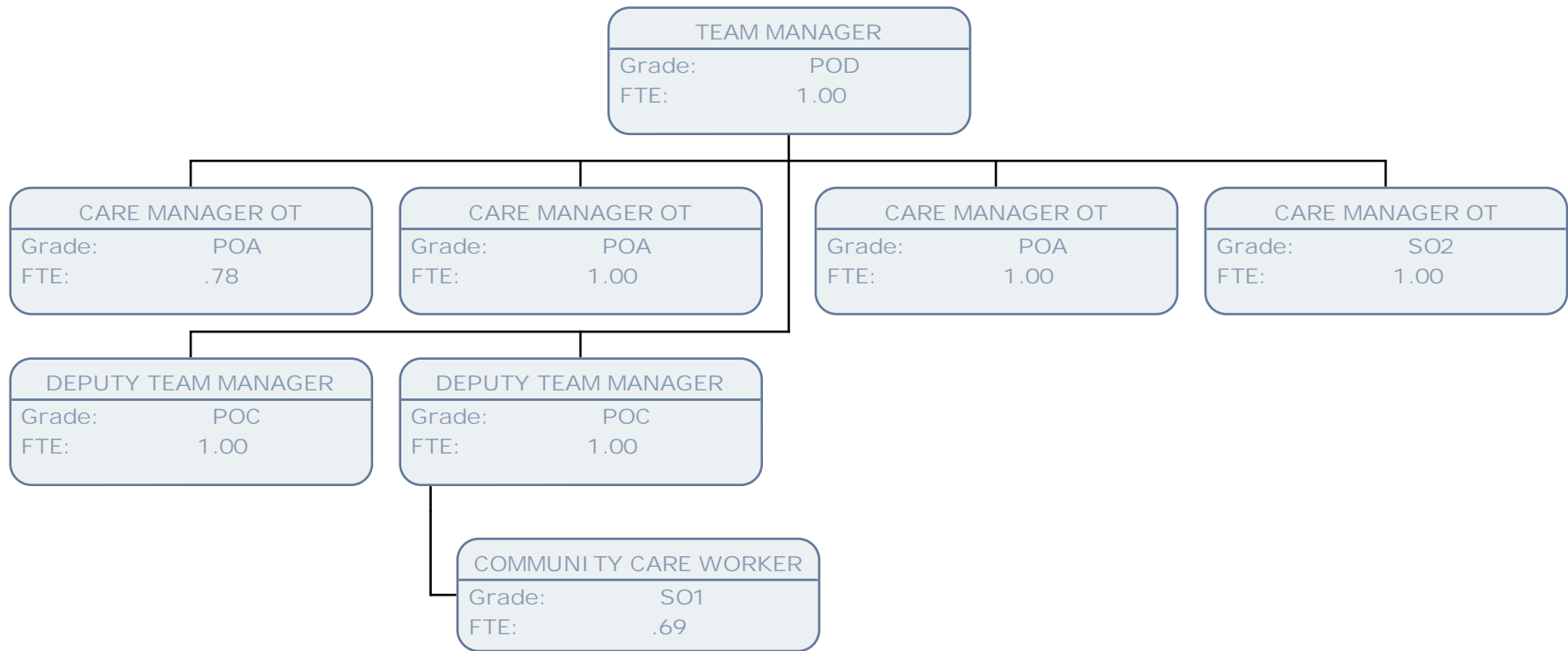

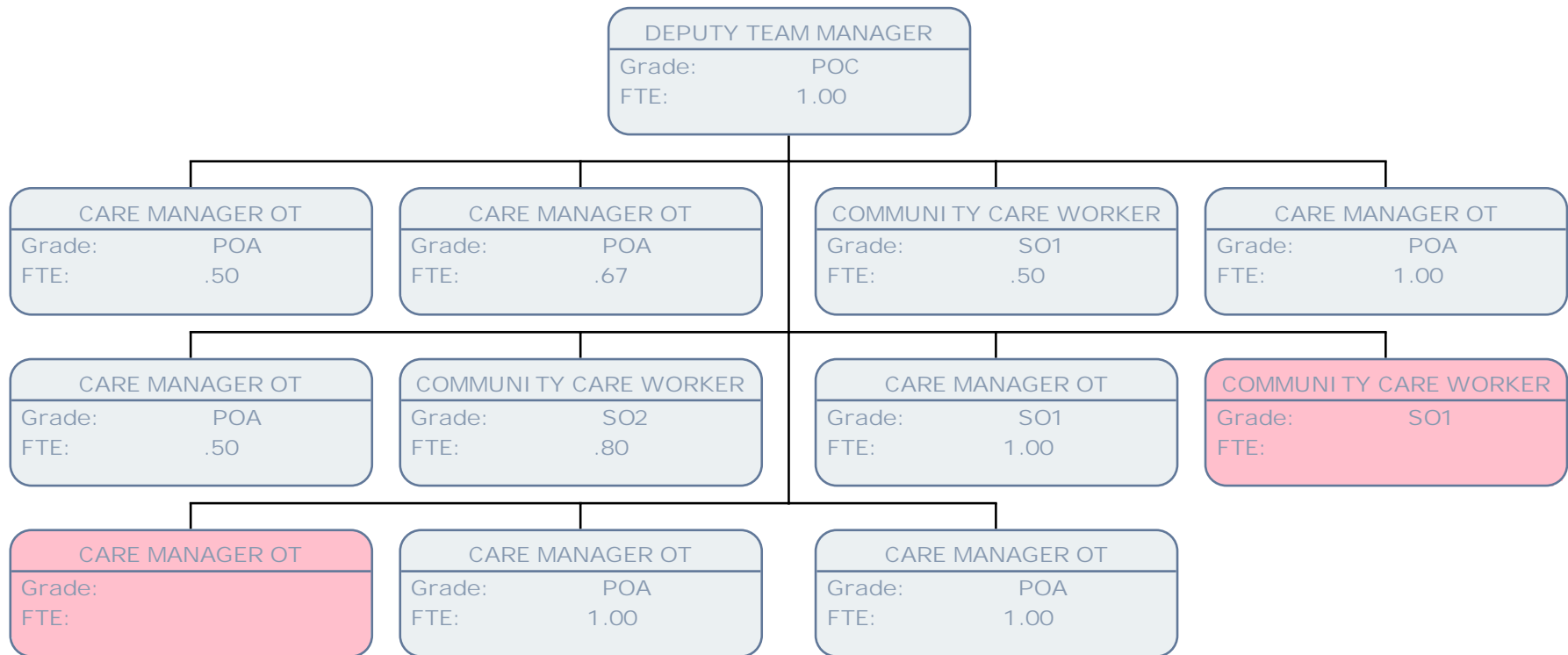

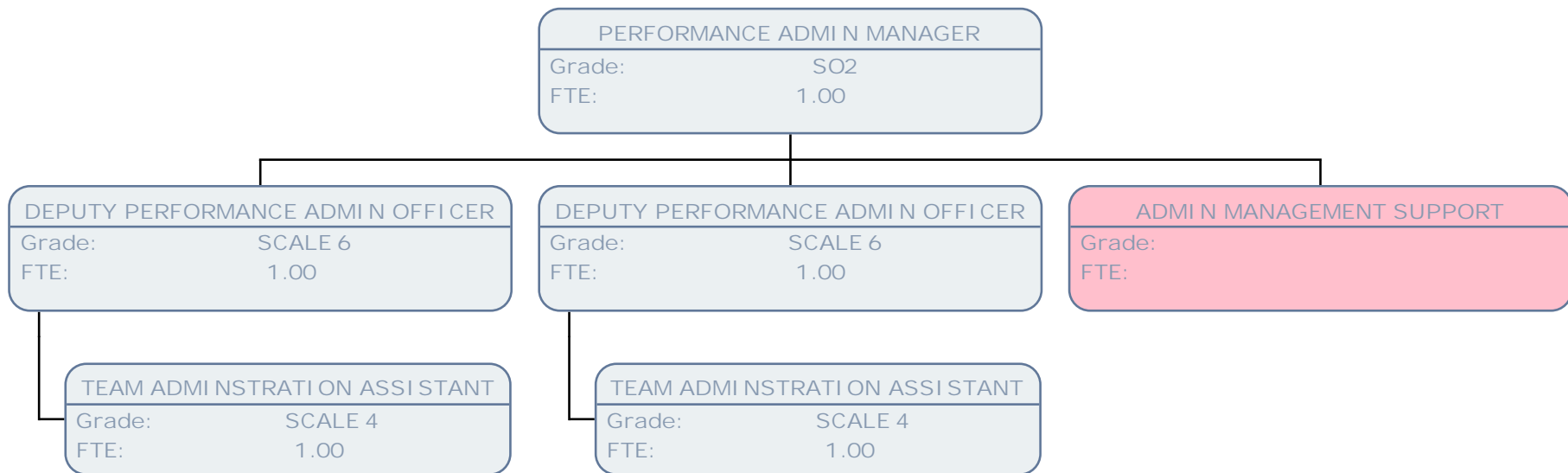

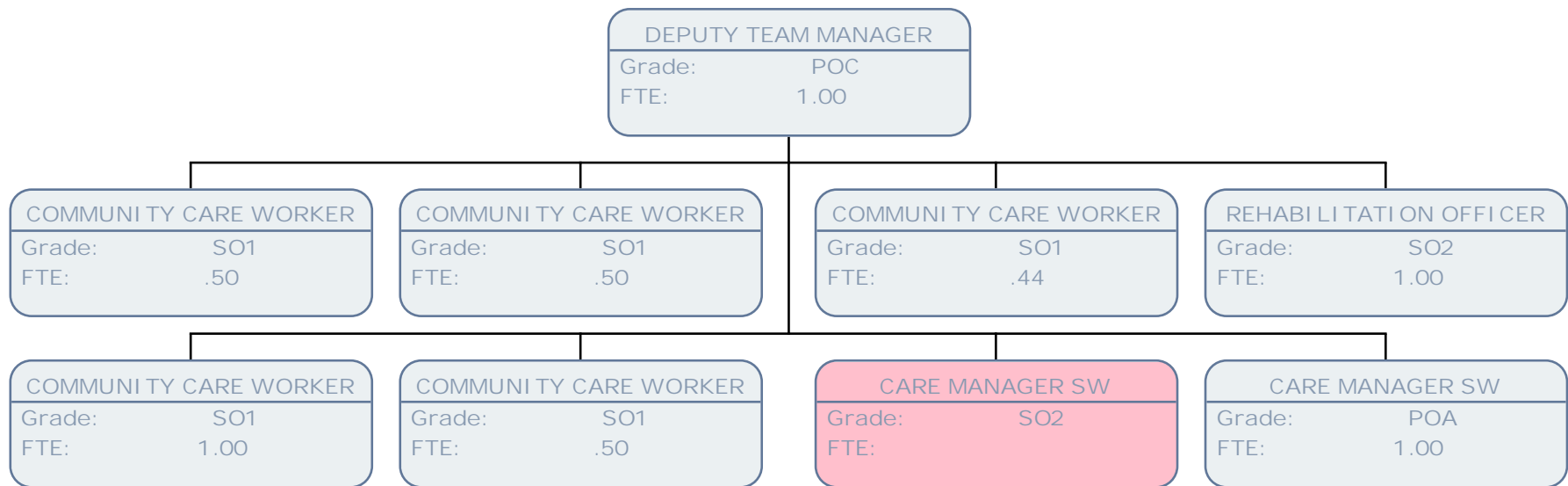

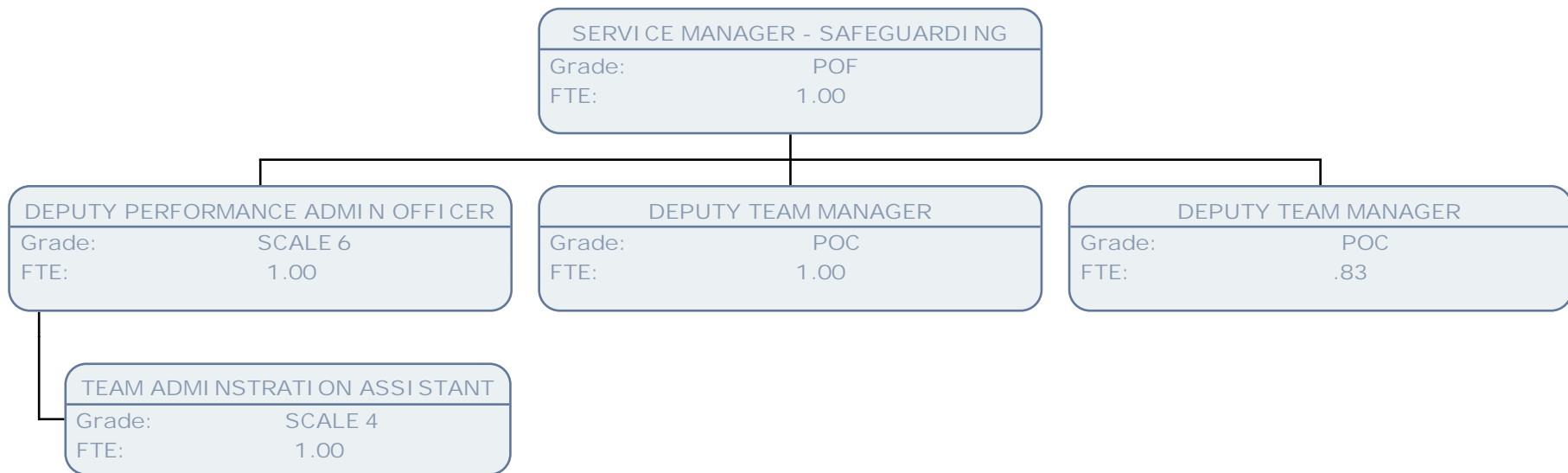

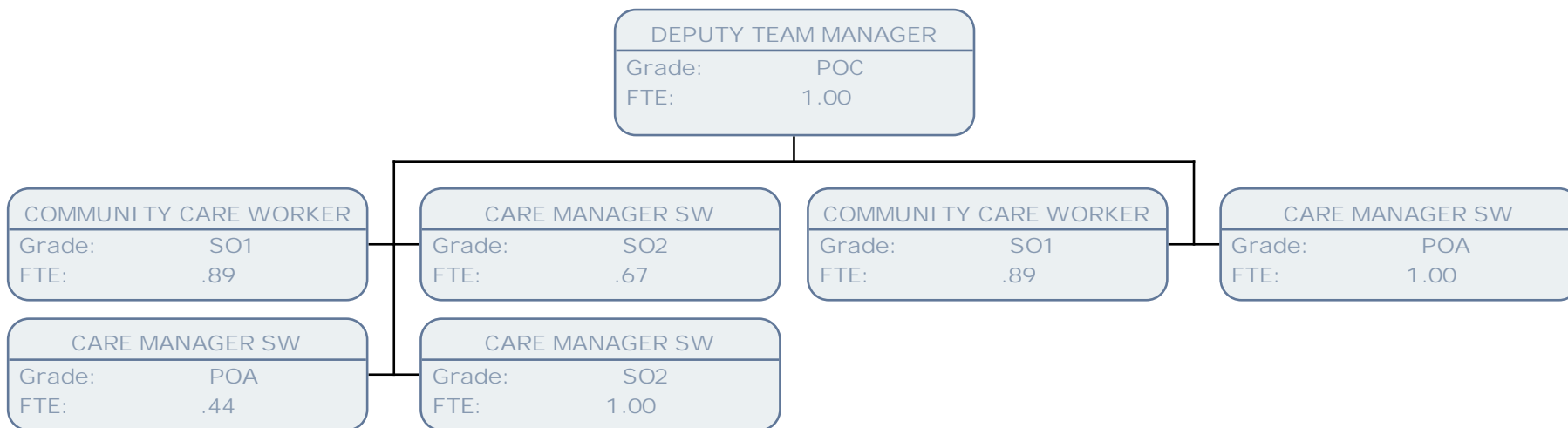

DEPUTY TEAM MANAGER	
Grade:	POC
FTE:	.83

CARE MANAGER SW	
Grade:	POA
FTE:	1.00

CARE MANAGER SW	
Grade:	POA
FTE:	.72

CARE MANAGER SW	
Grade:	SO2
FTE:	1.00

CARE MANAGER SW	
Grade:	POA
FTE:	.67

COMMUNITY CARE WORKER	
Grade:	SO1
FTE:	1.00

COMMUNITY CARE WORKER	
Grade:	SO1
FTE:	1.00



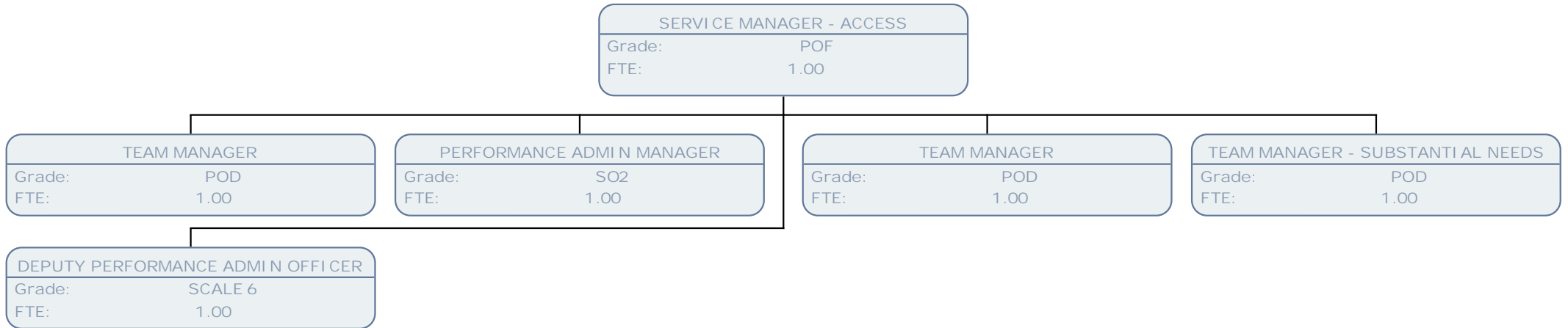

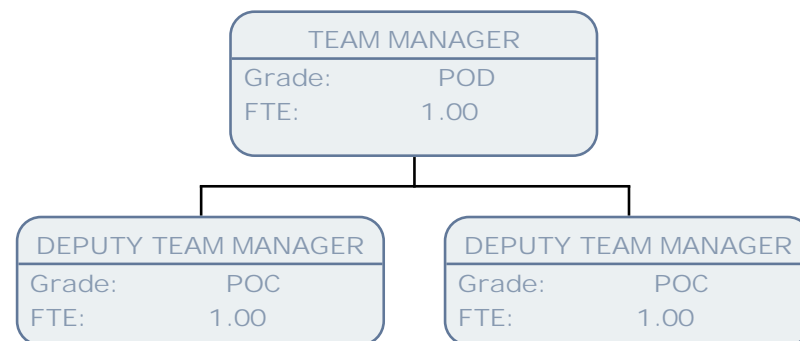

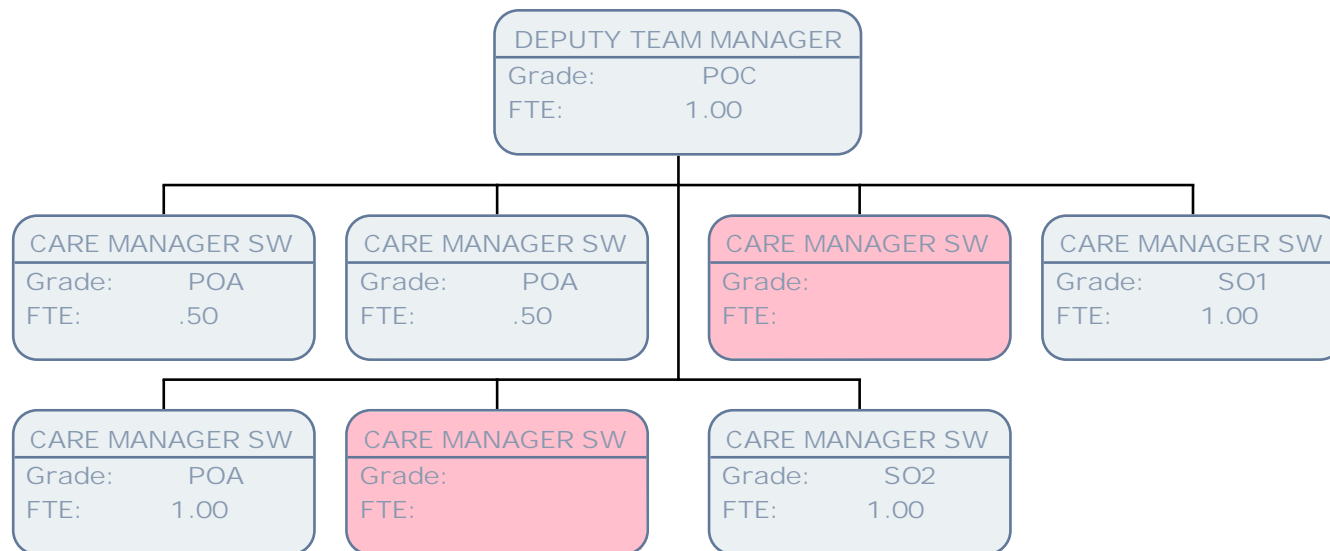

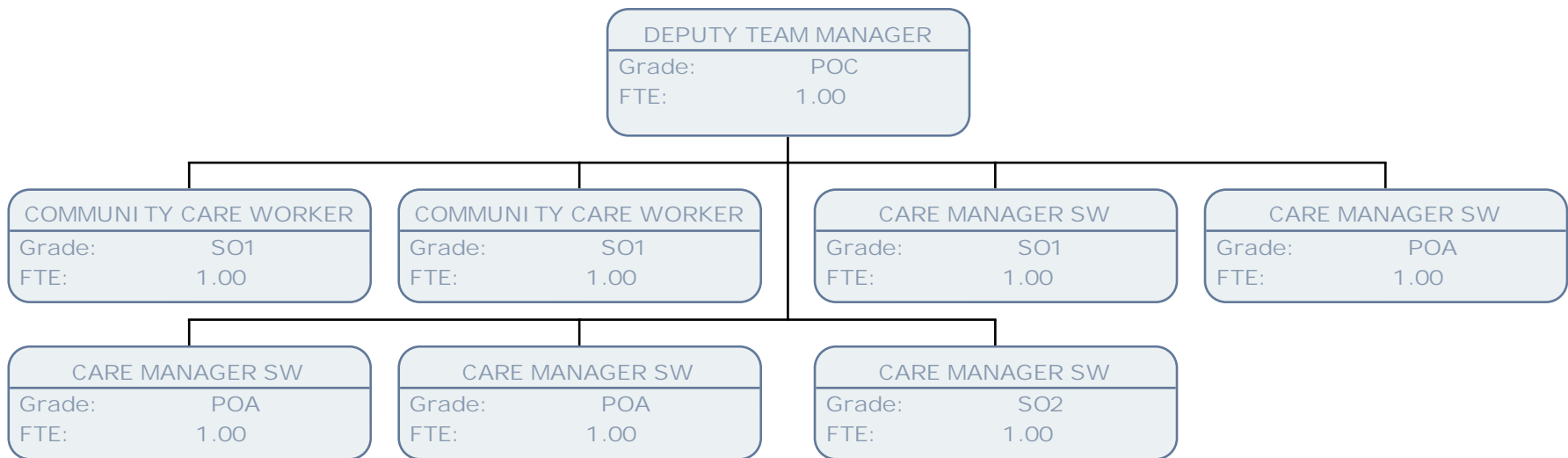

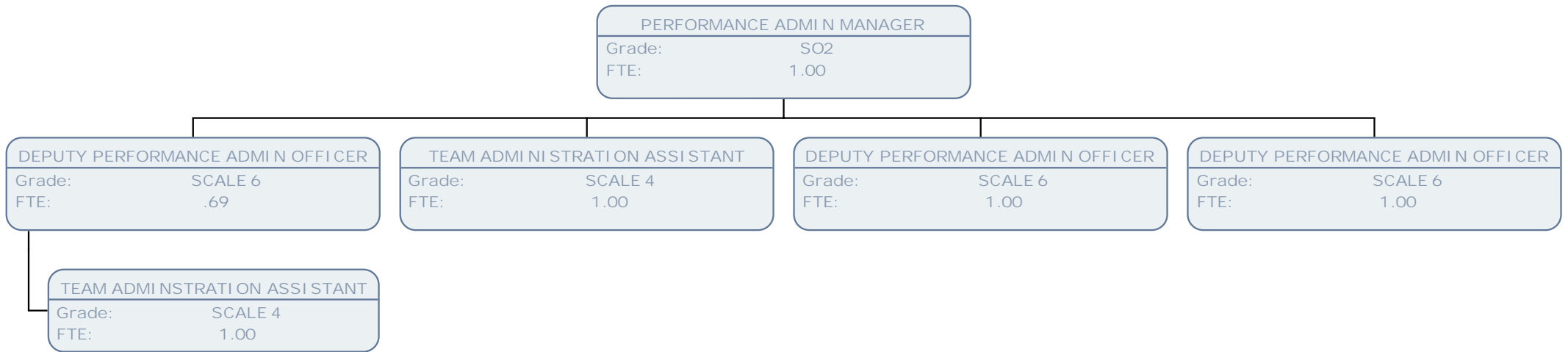

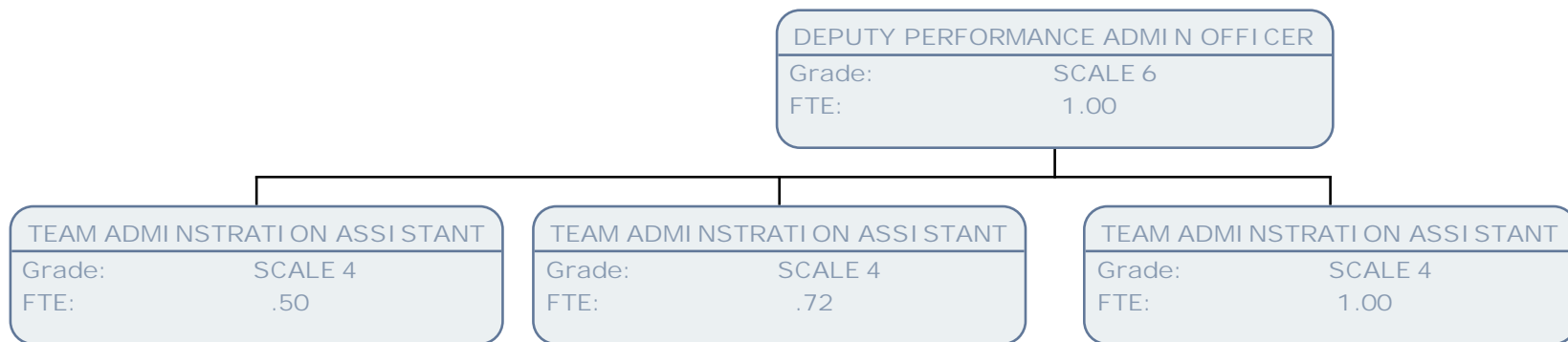

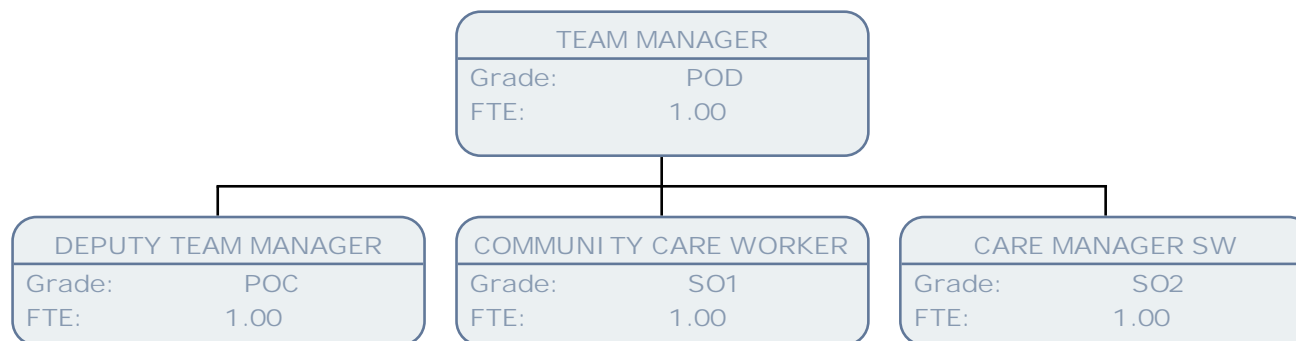

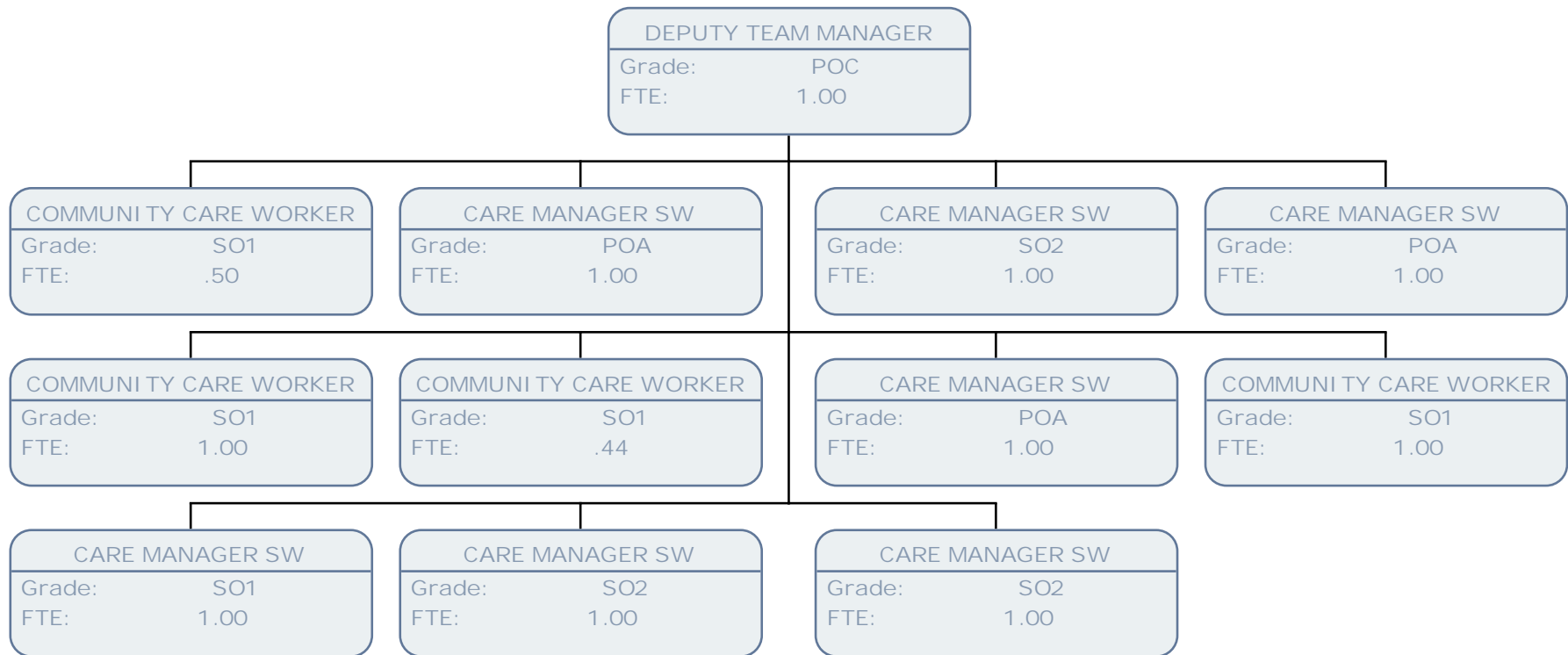

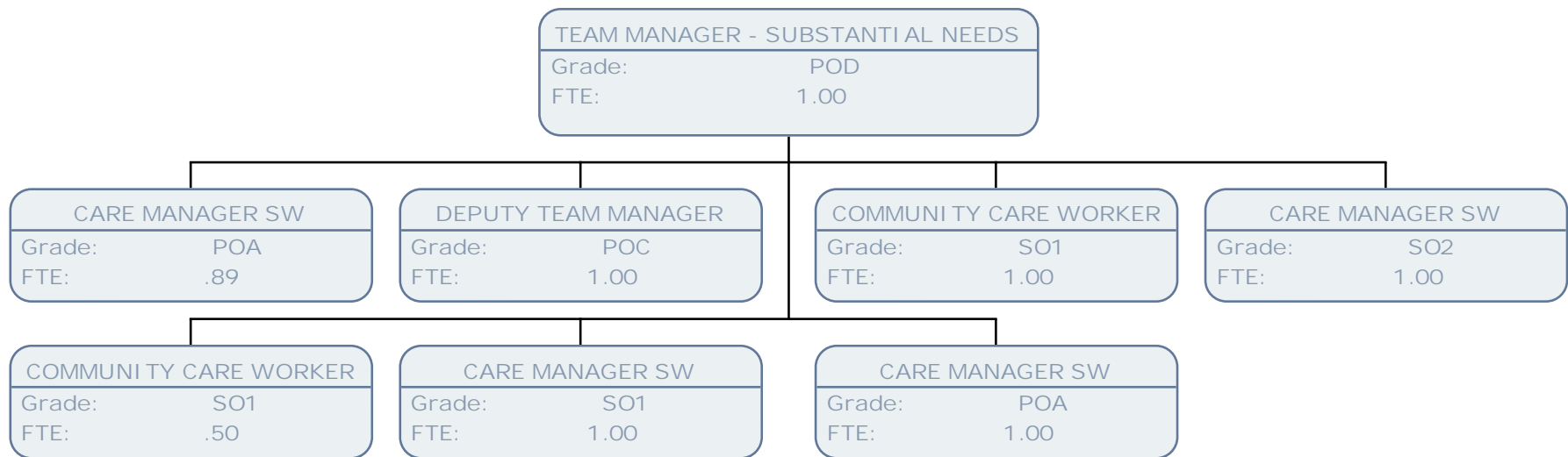

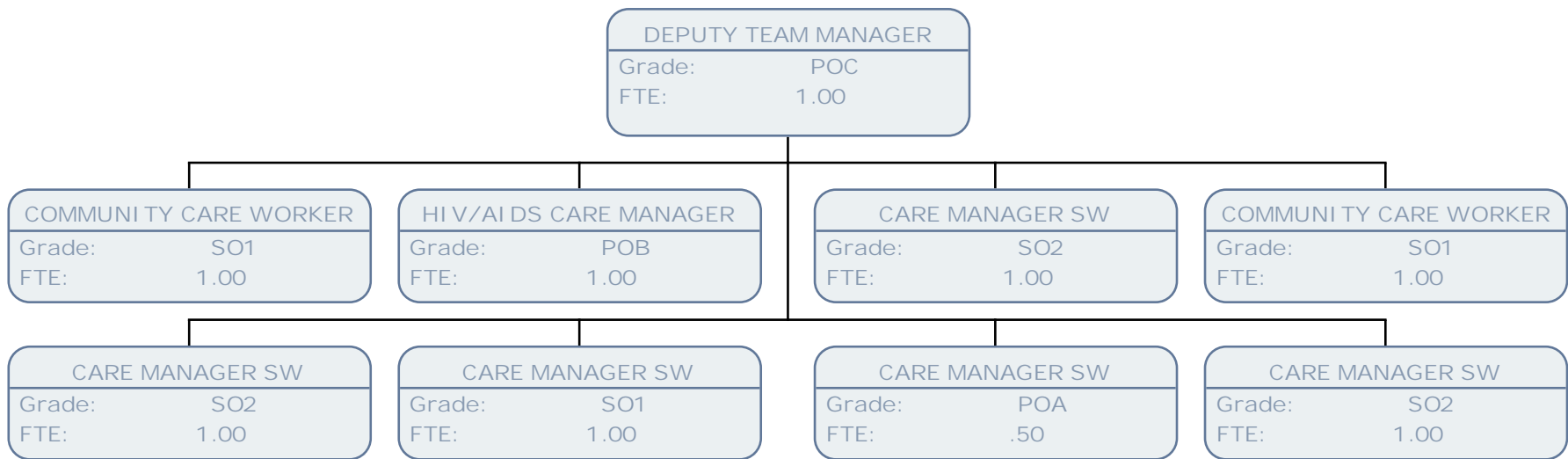

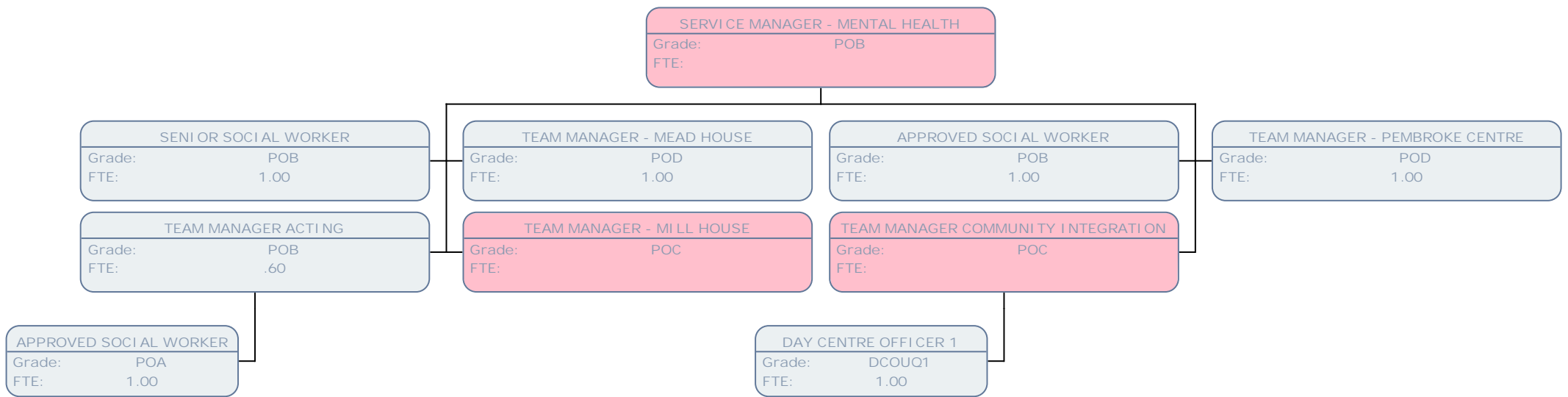

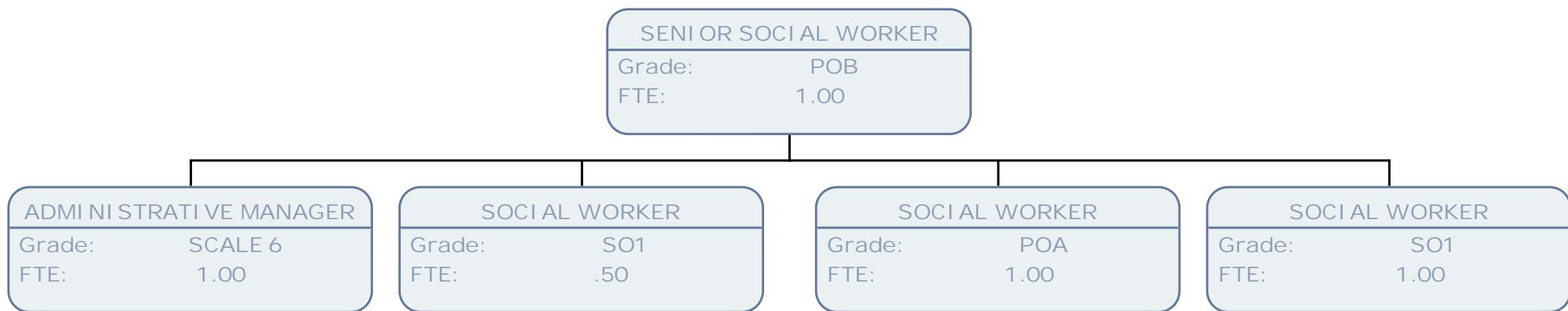

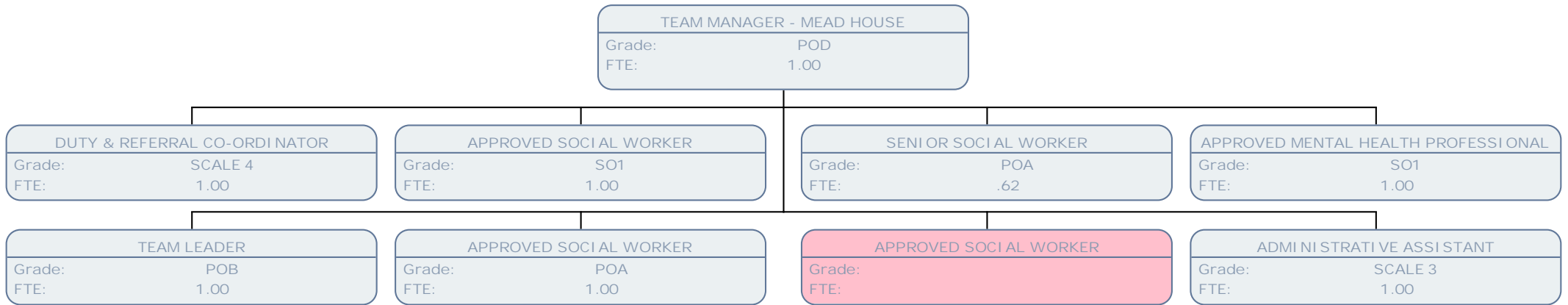

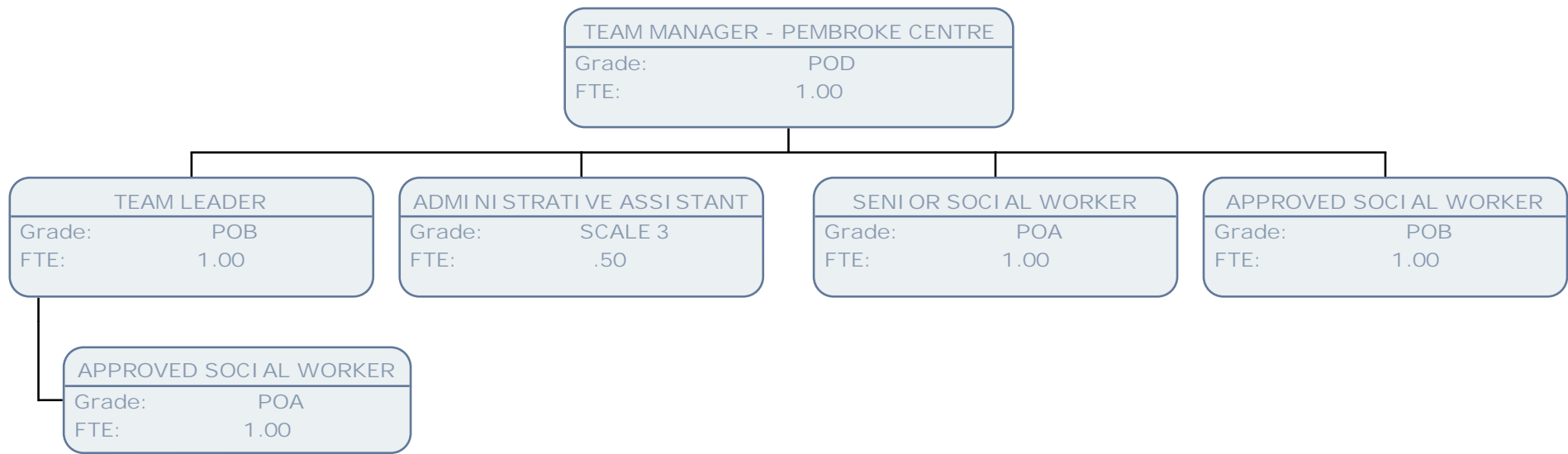

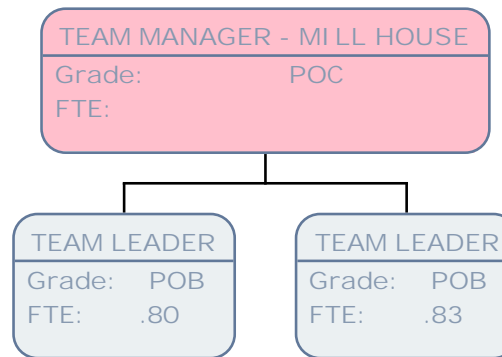

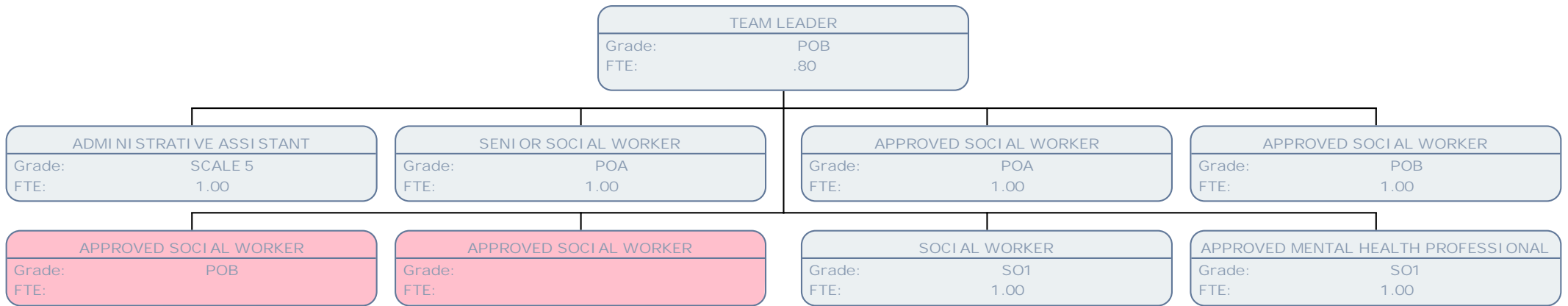

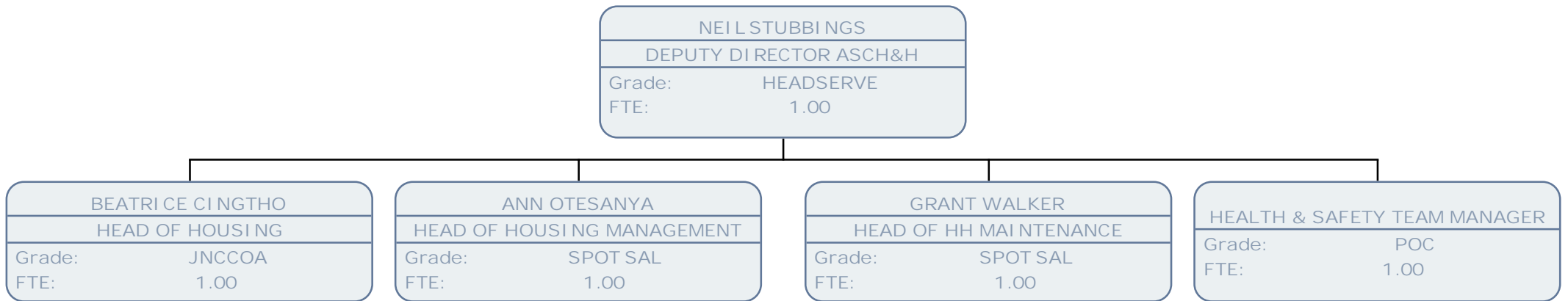

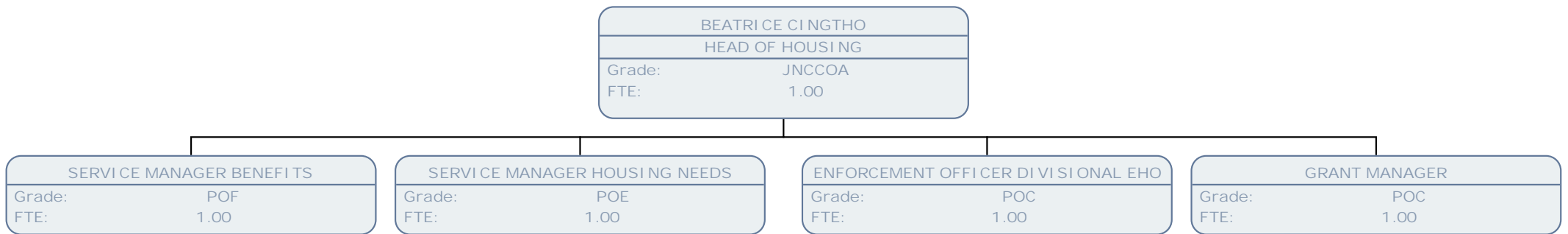

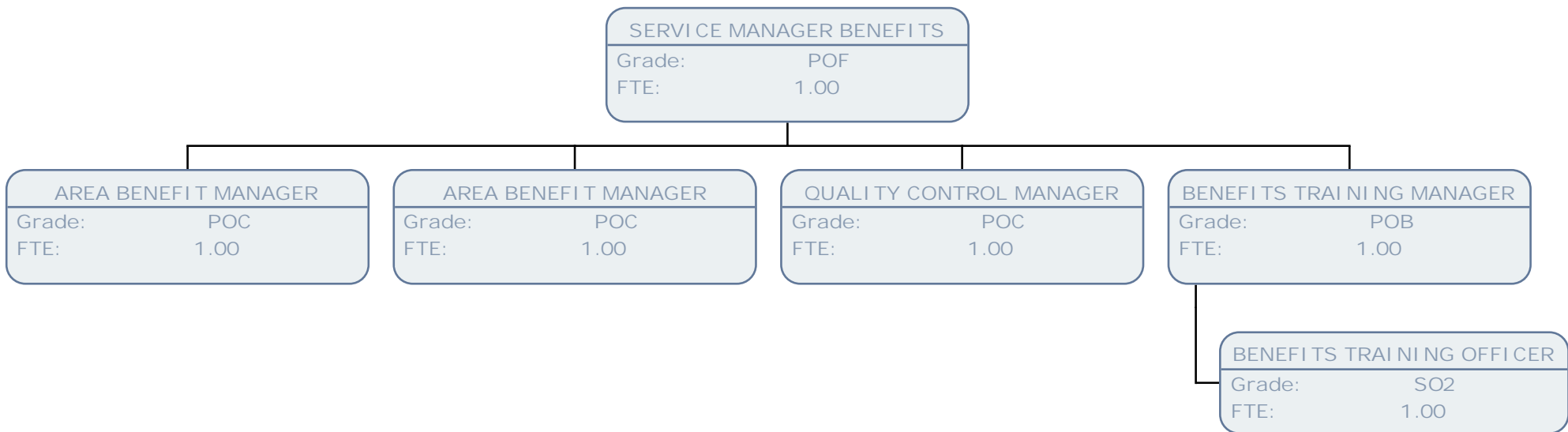

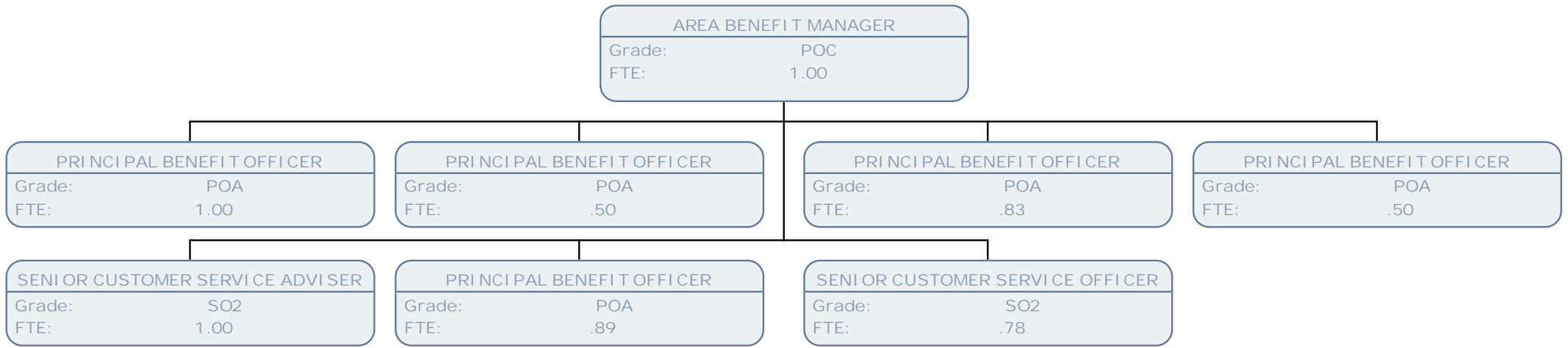

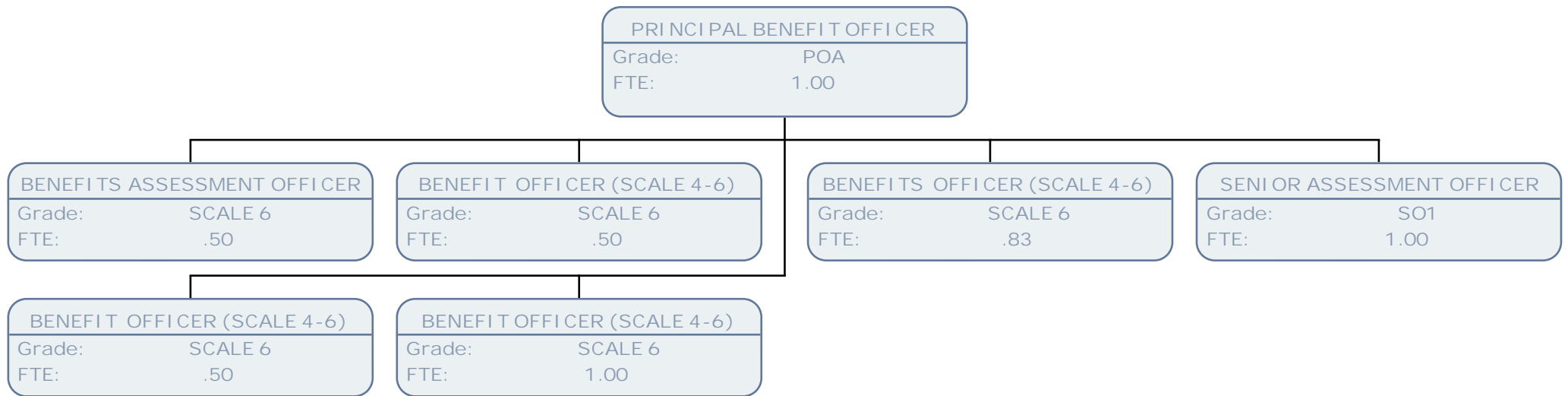

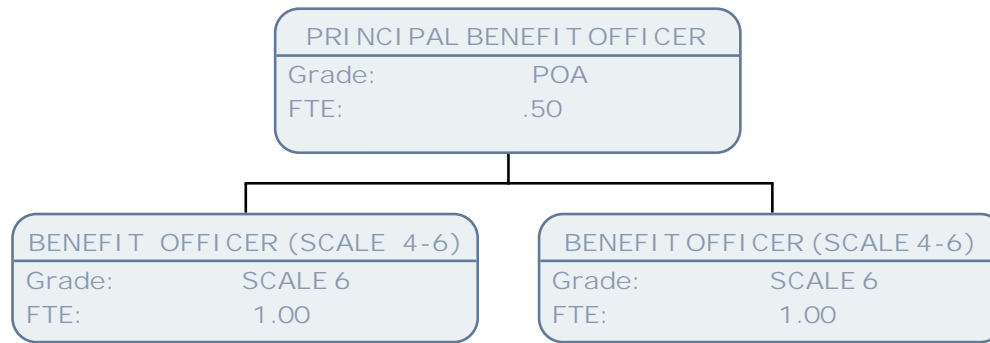

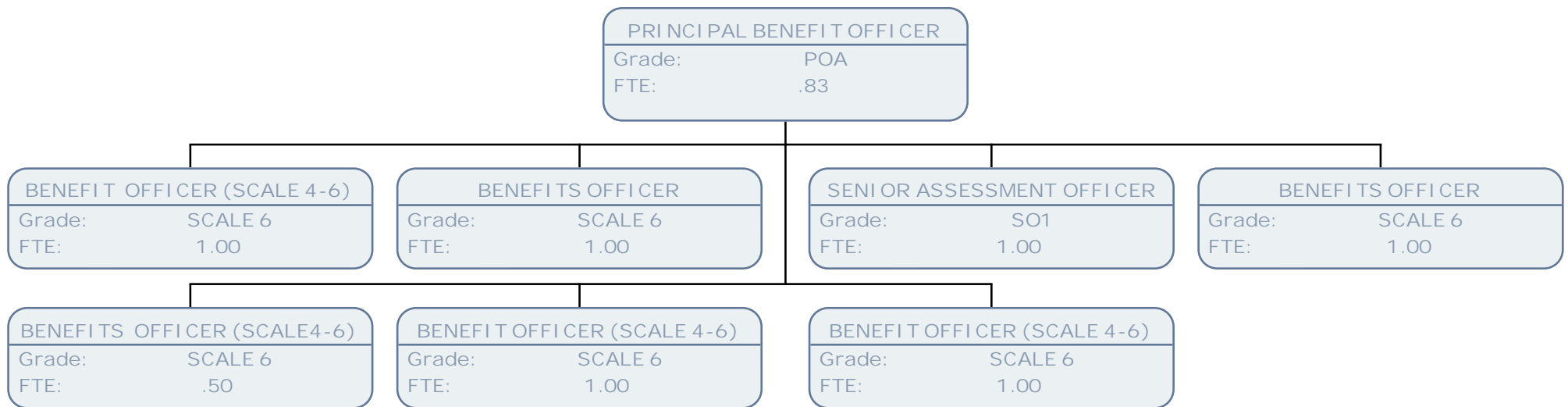

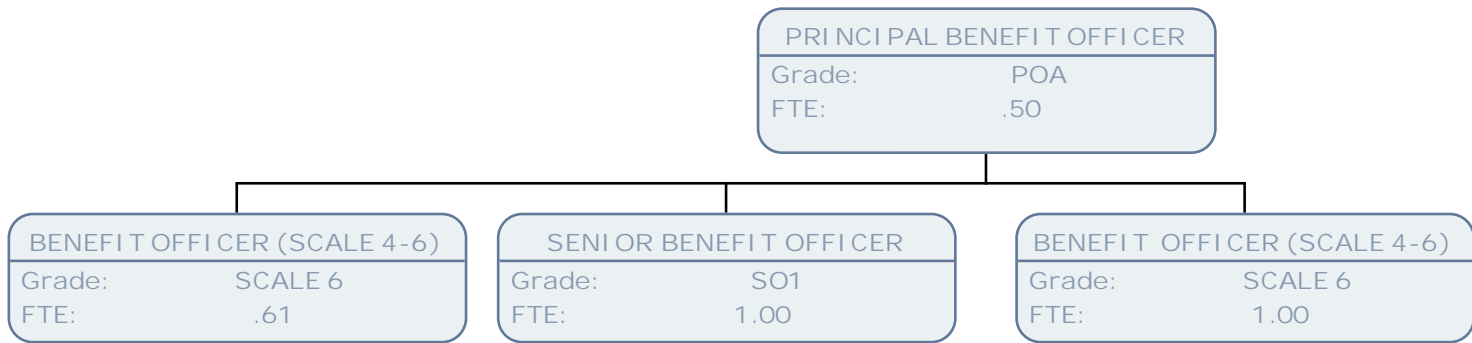

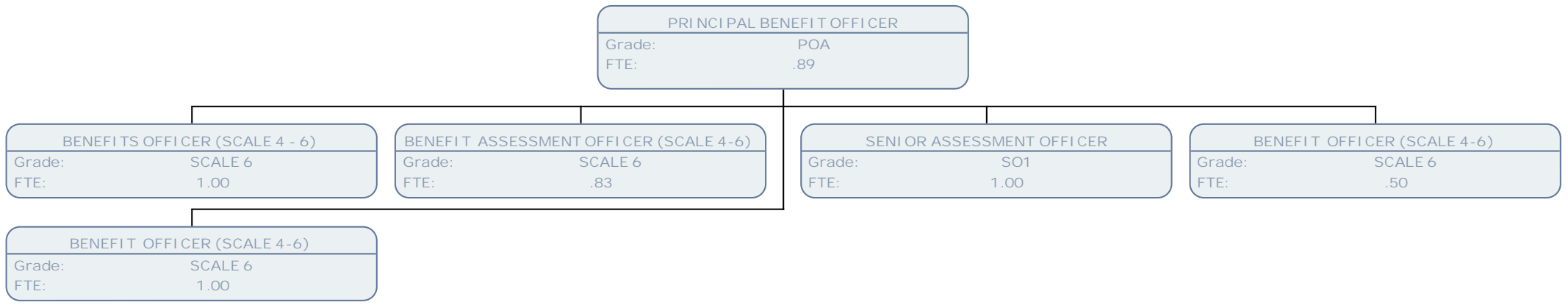

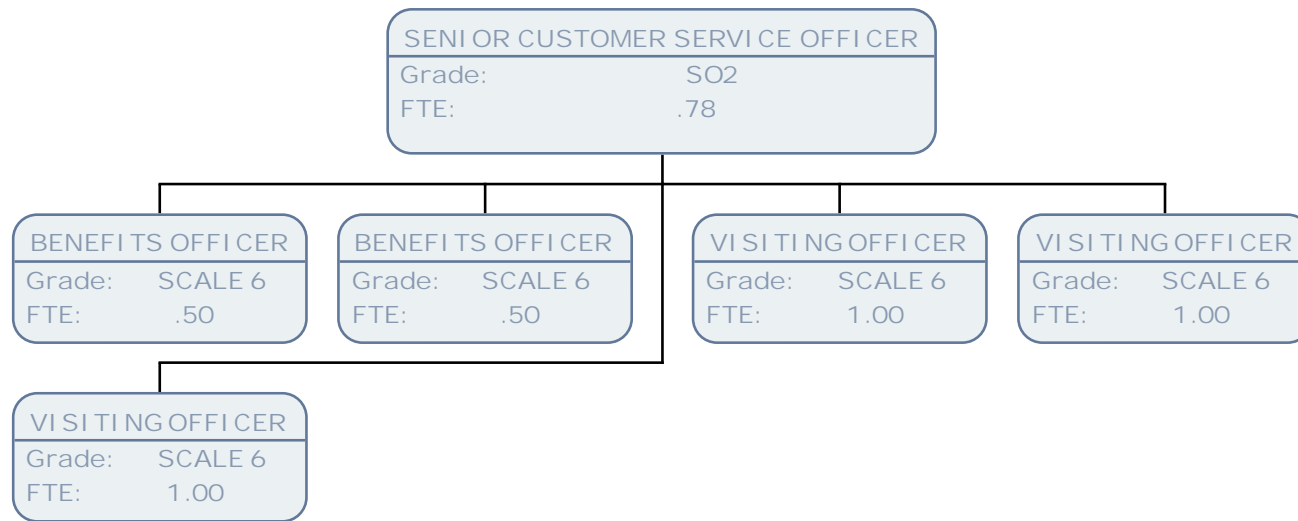

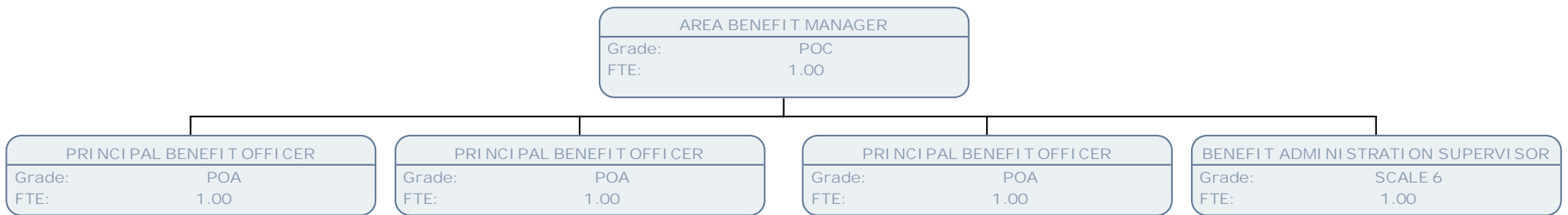

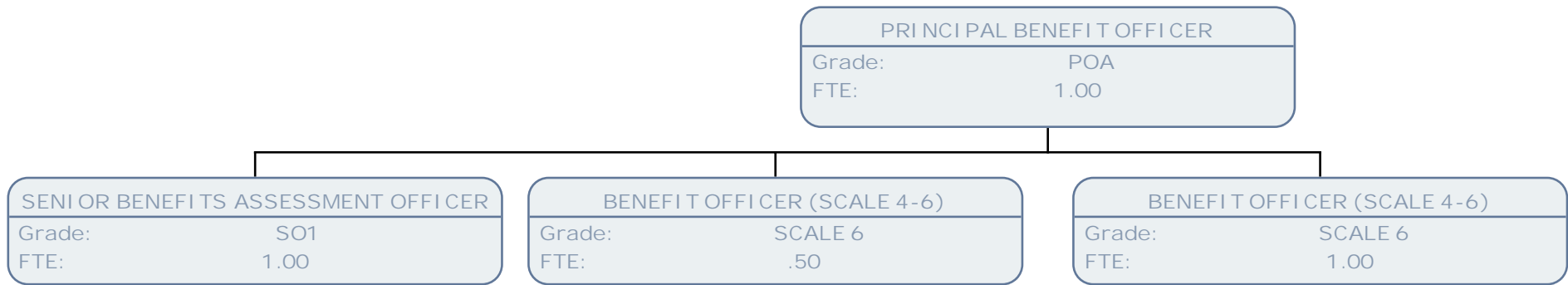

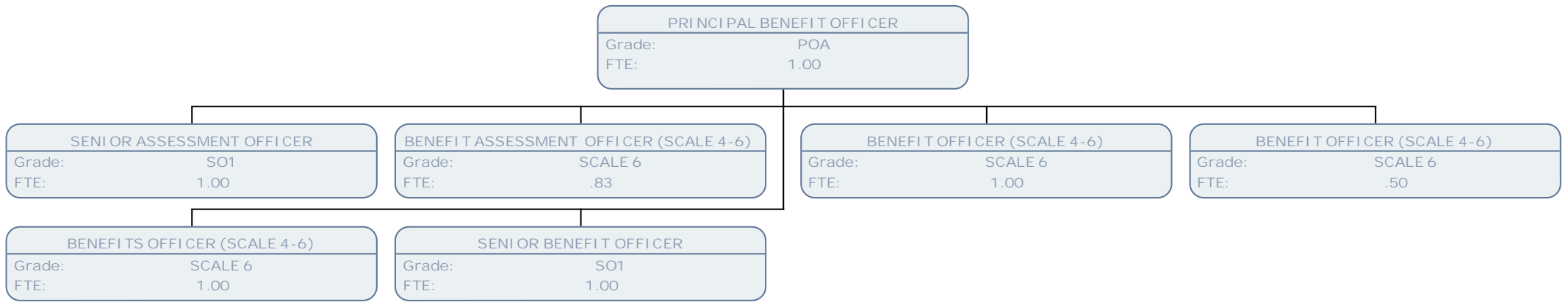

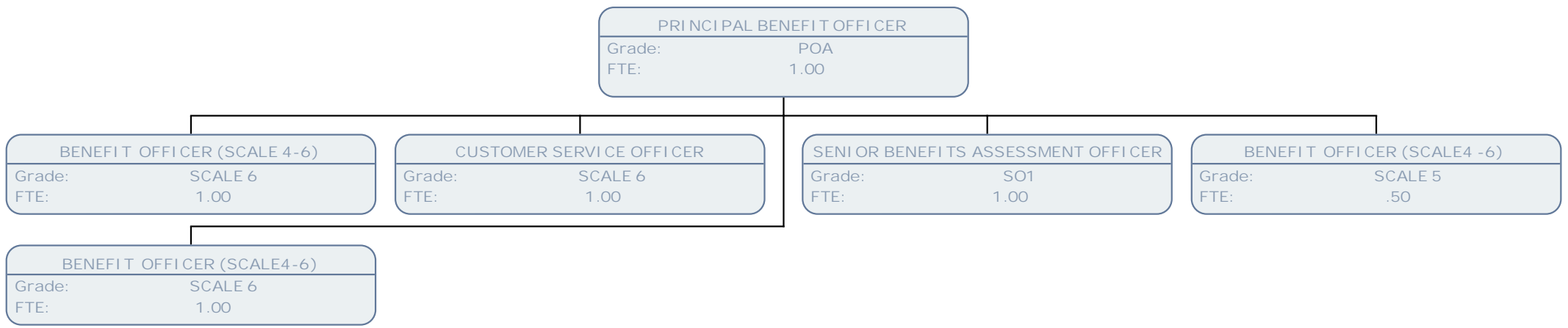

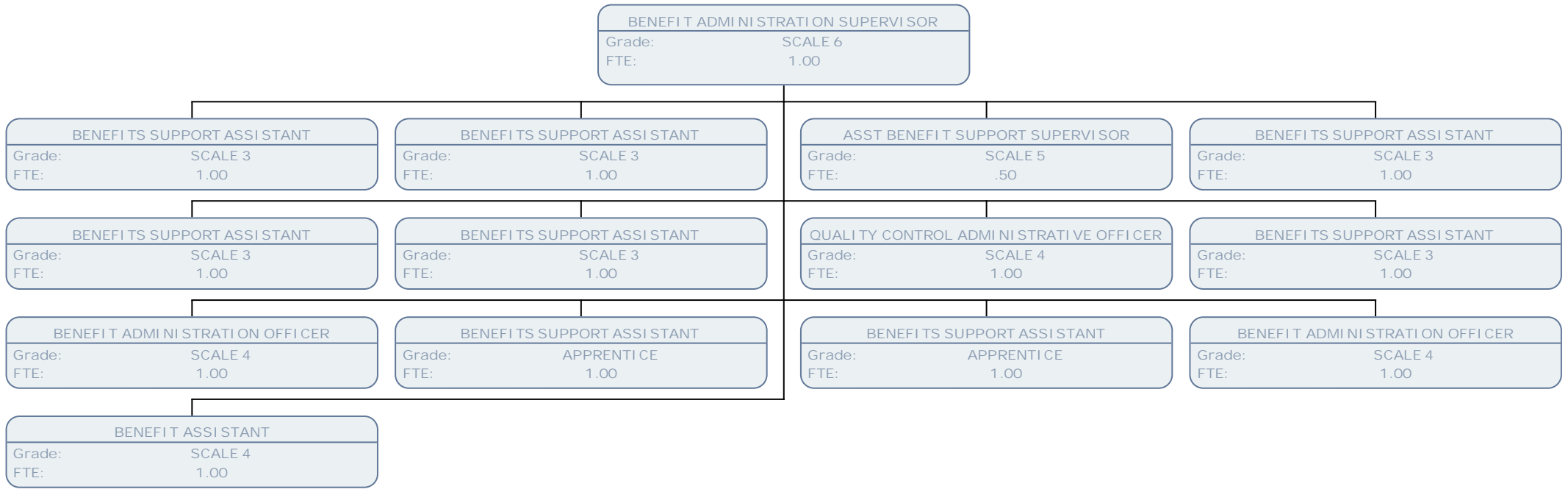

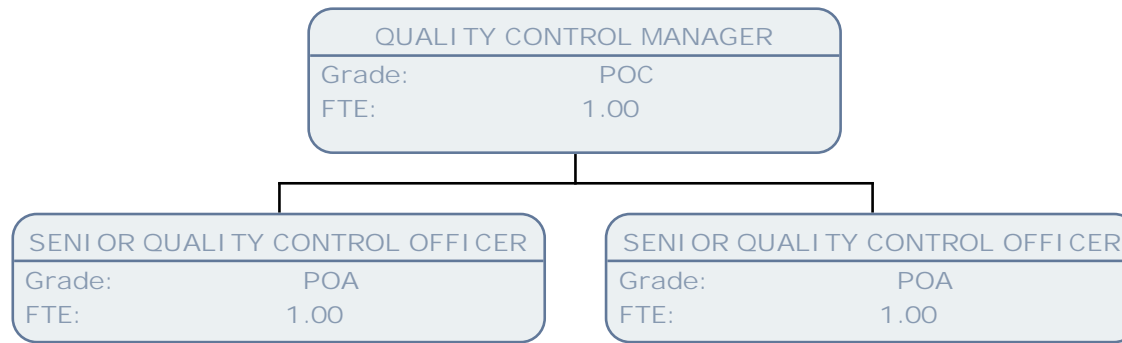

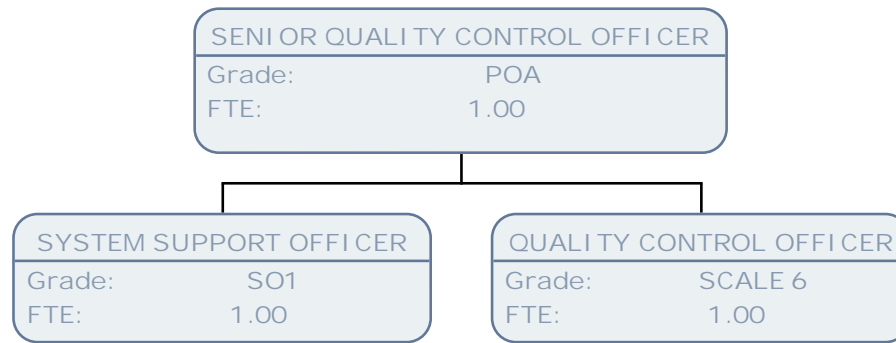

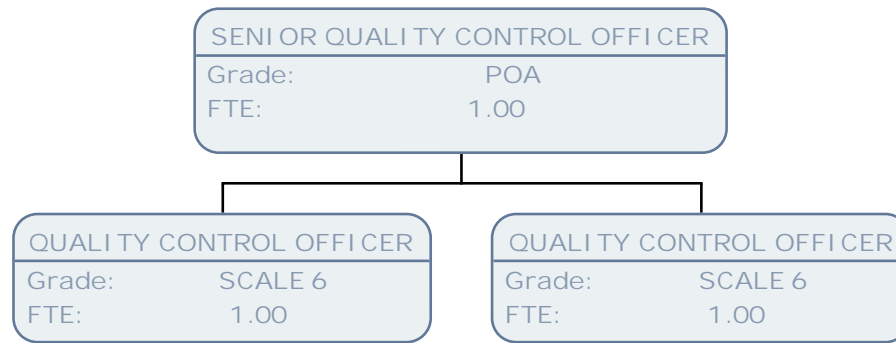

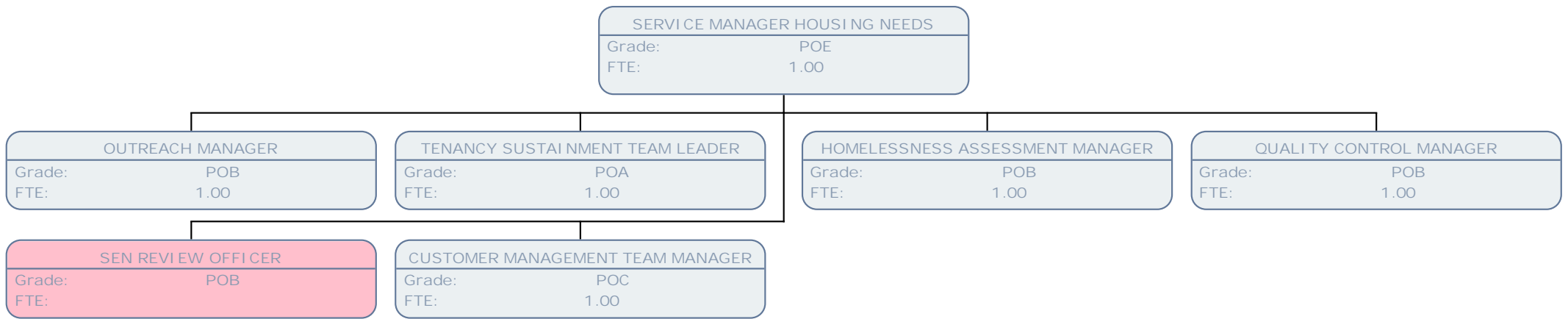

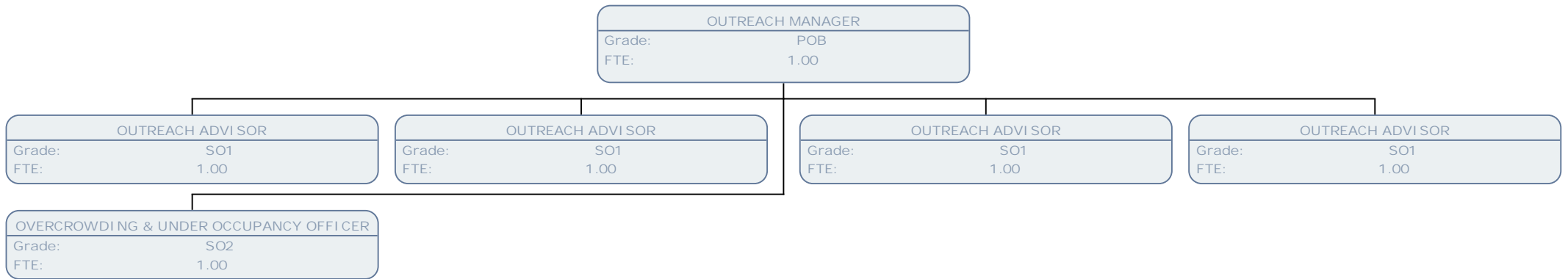

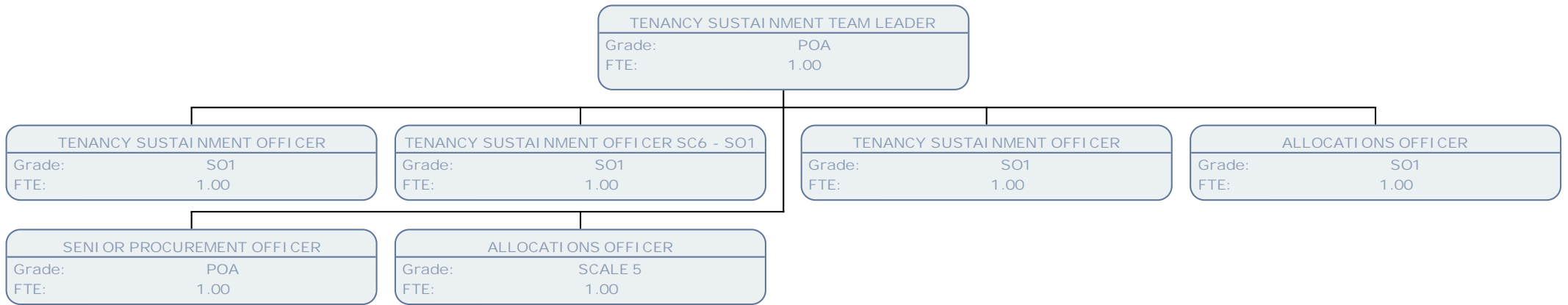

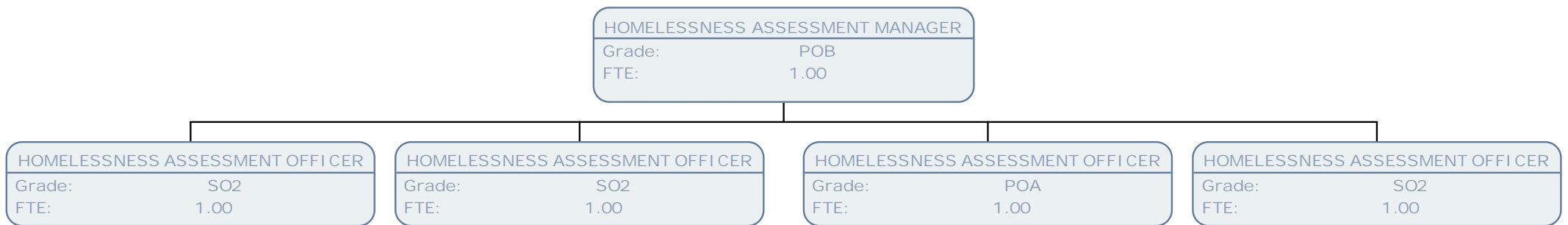

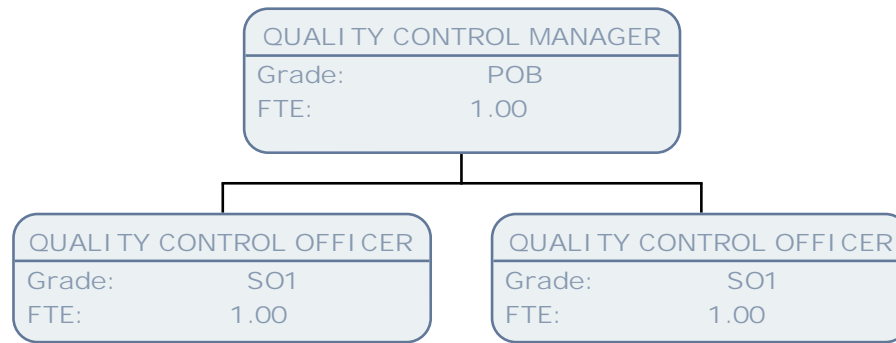

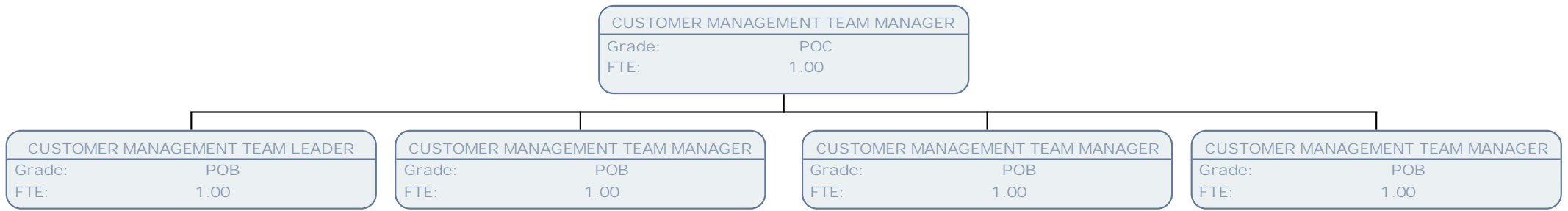

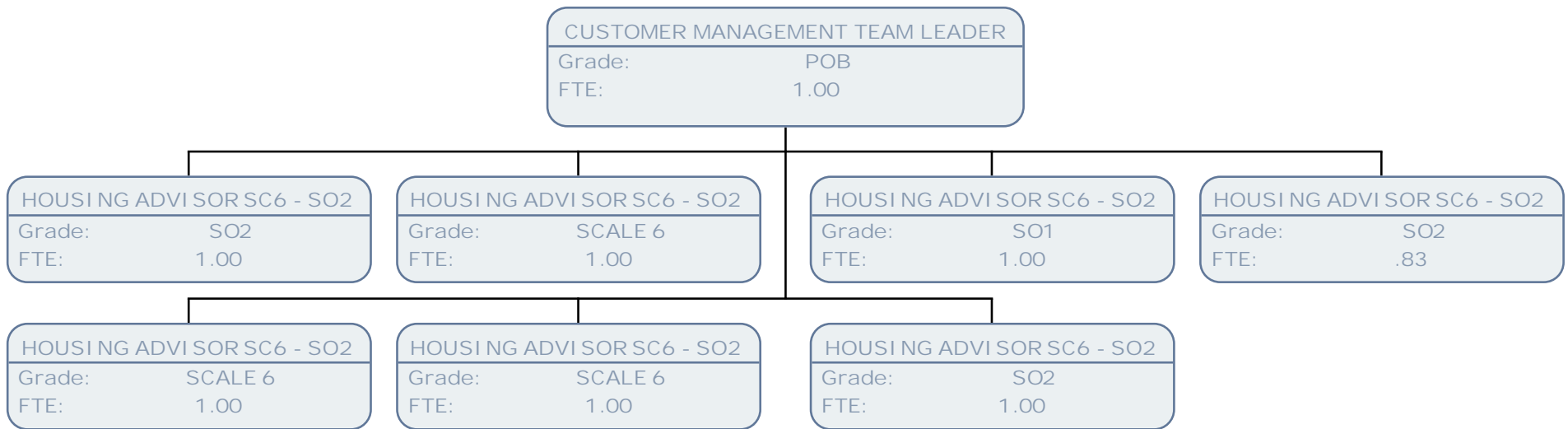

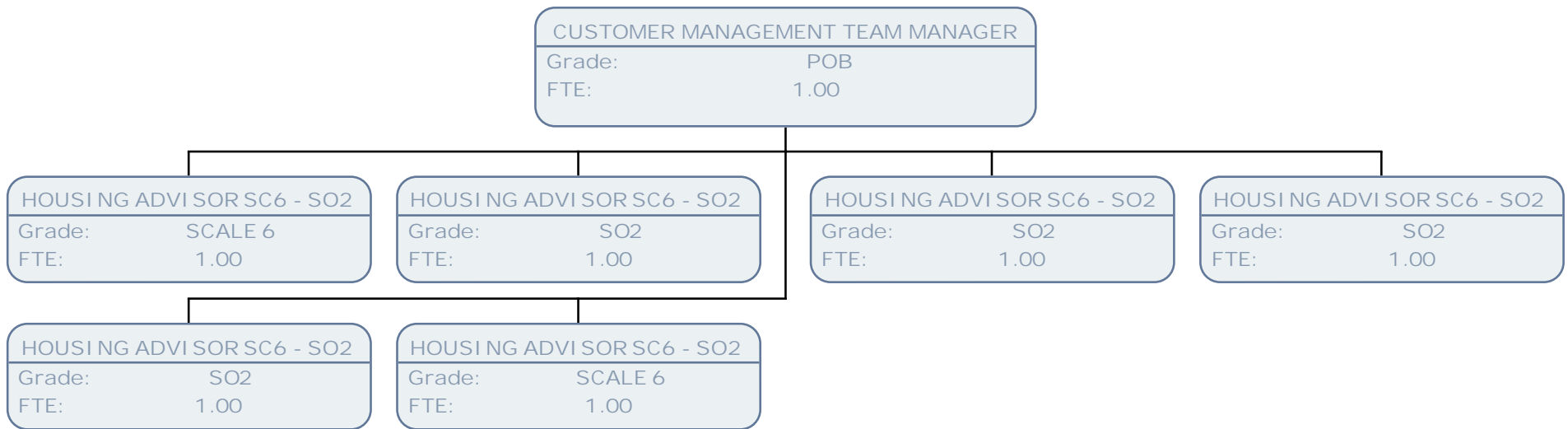

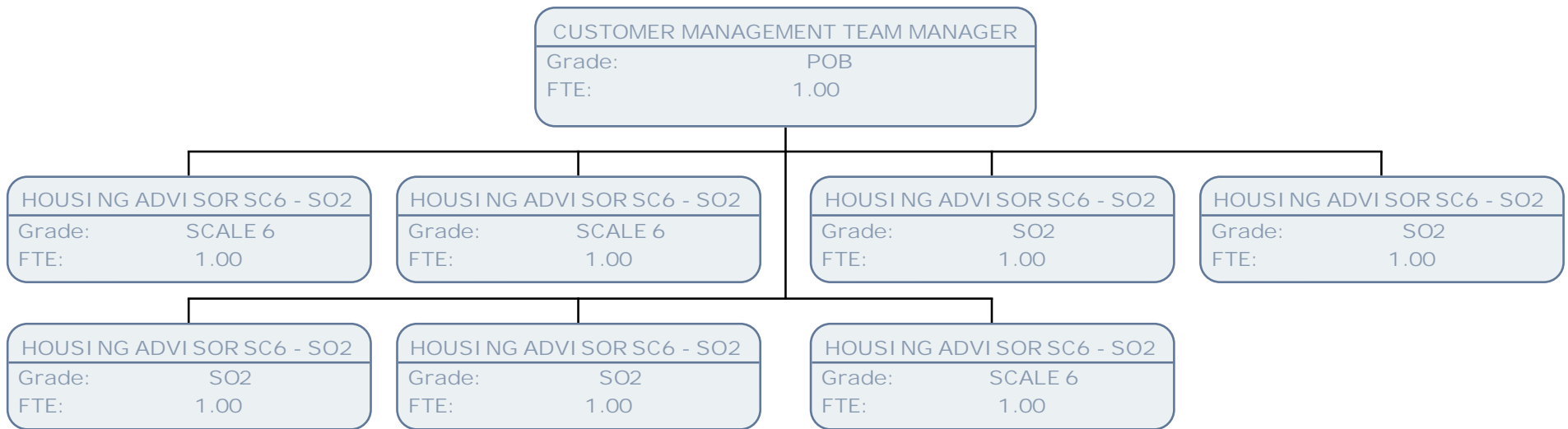

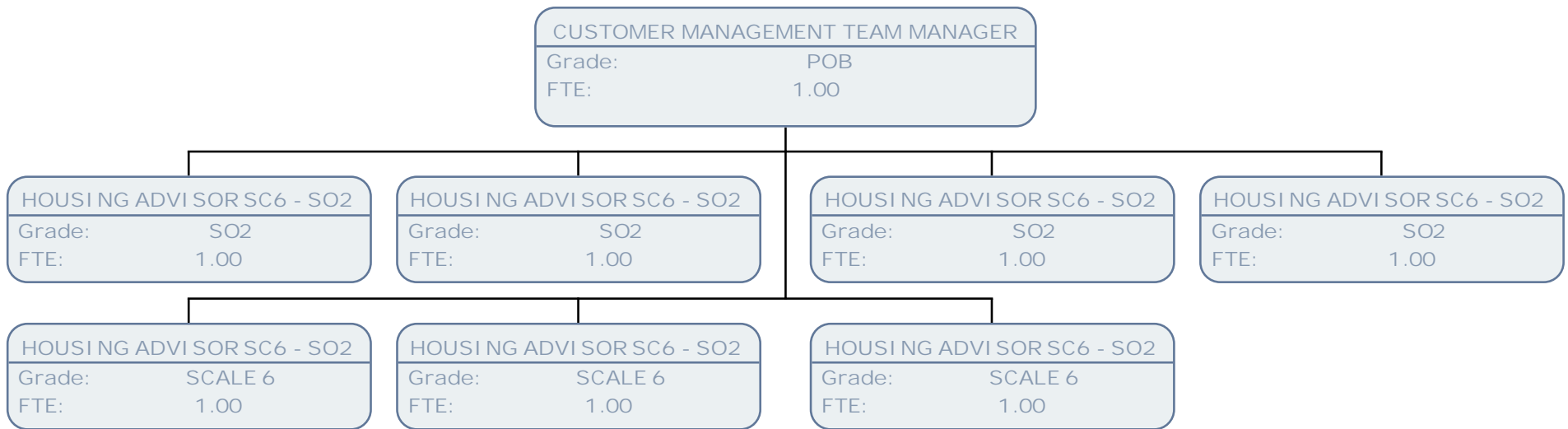

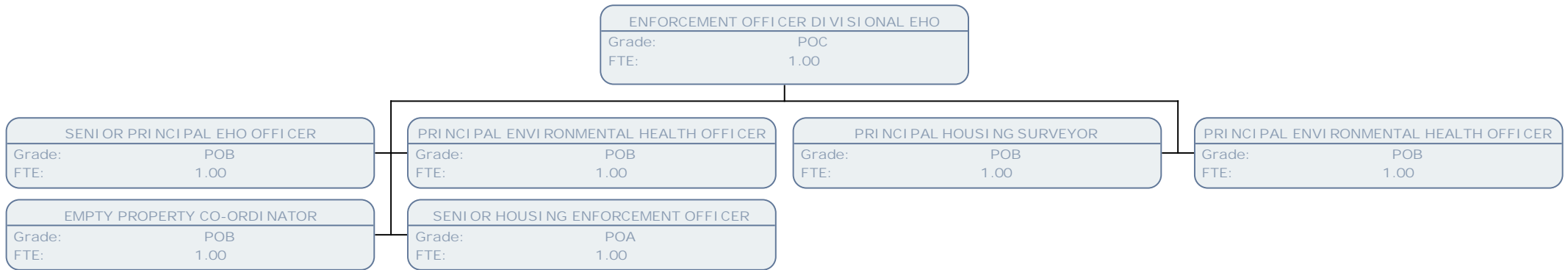

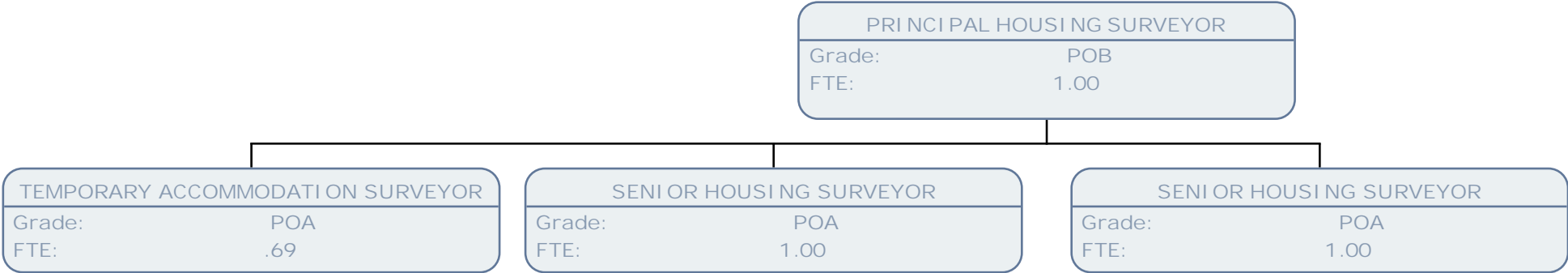

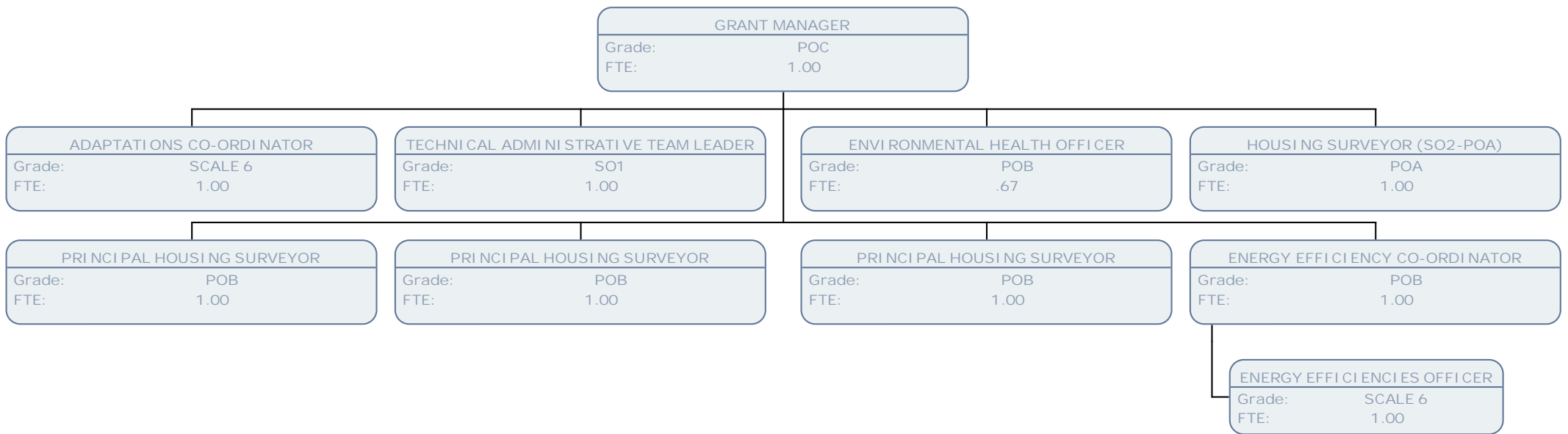

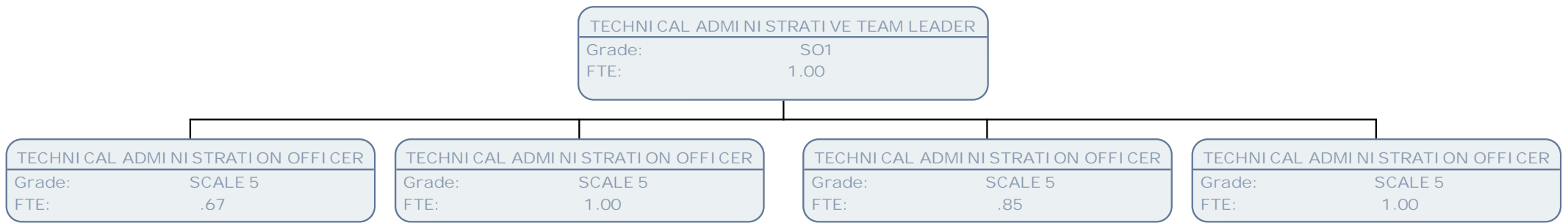

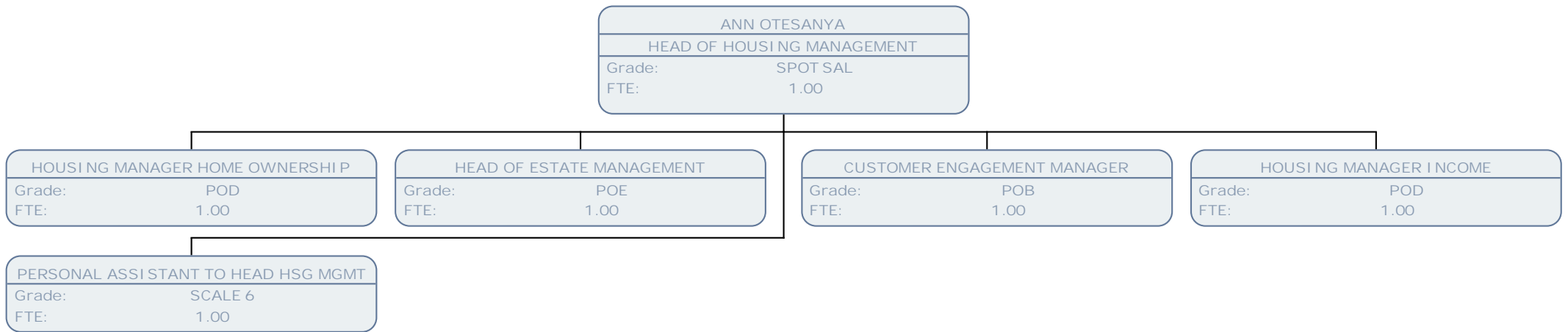

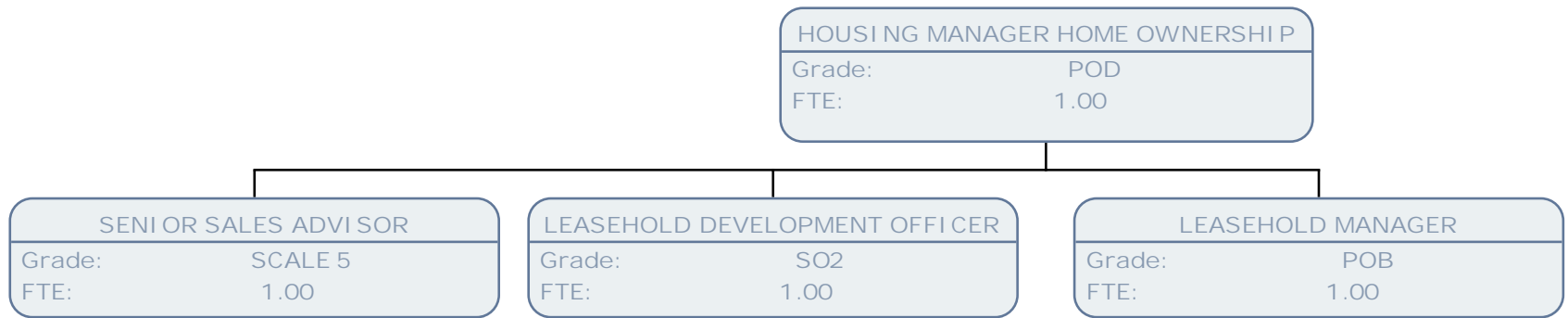

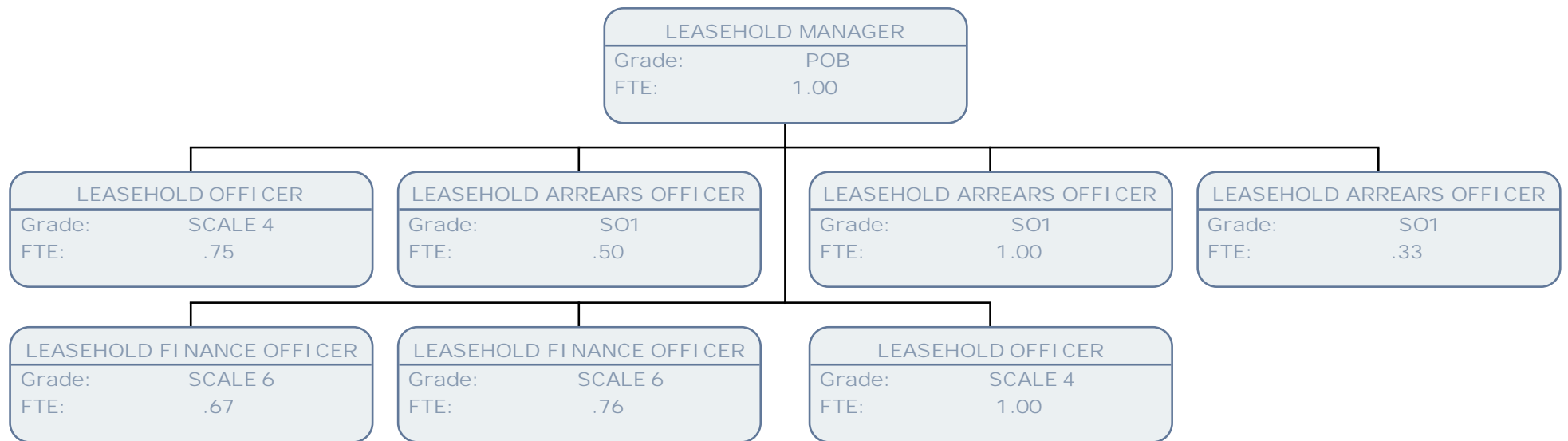

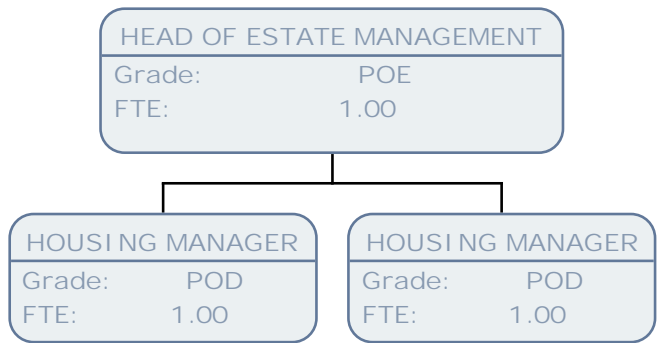

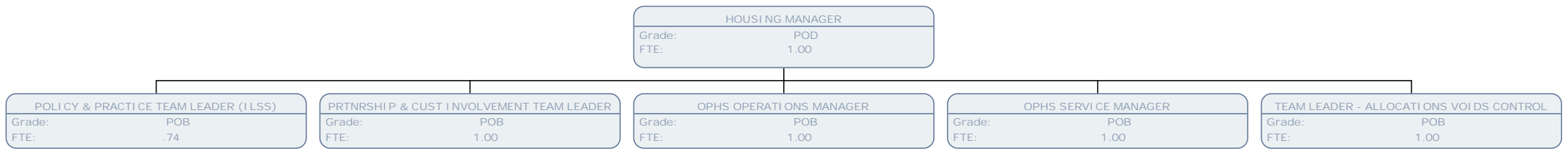

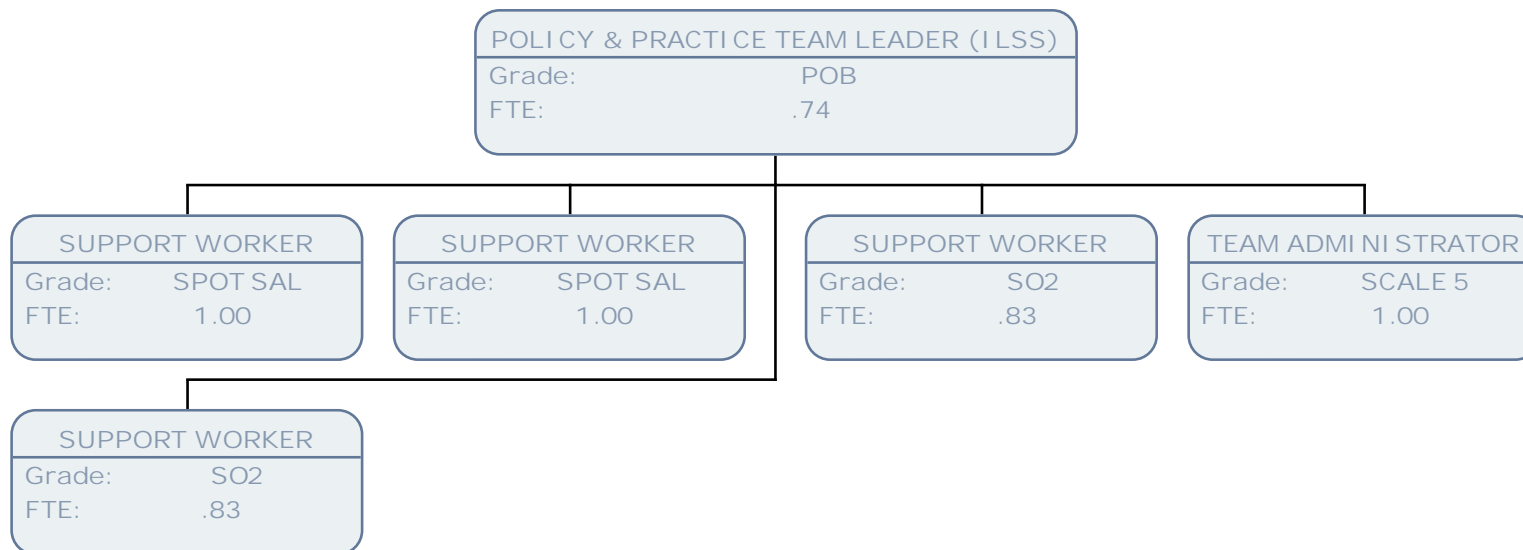

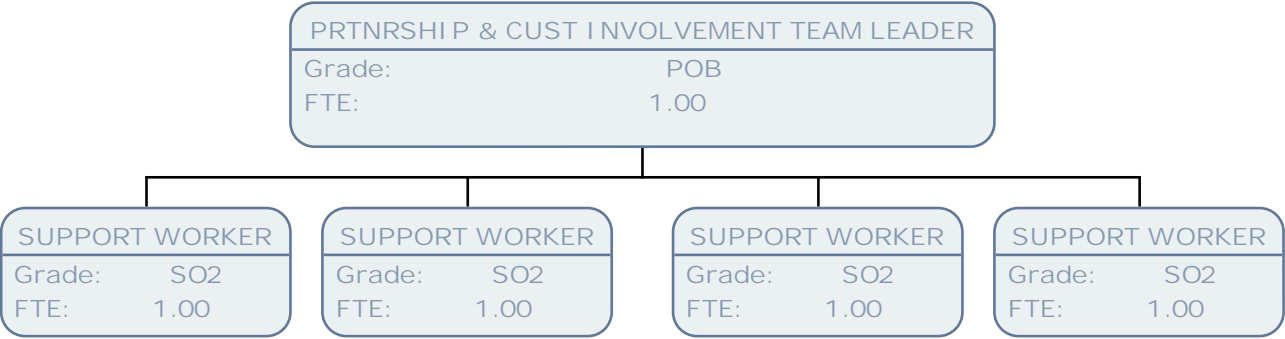

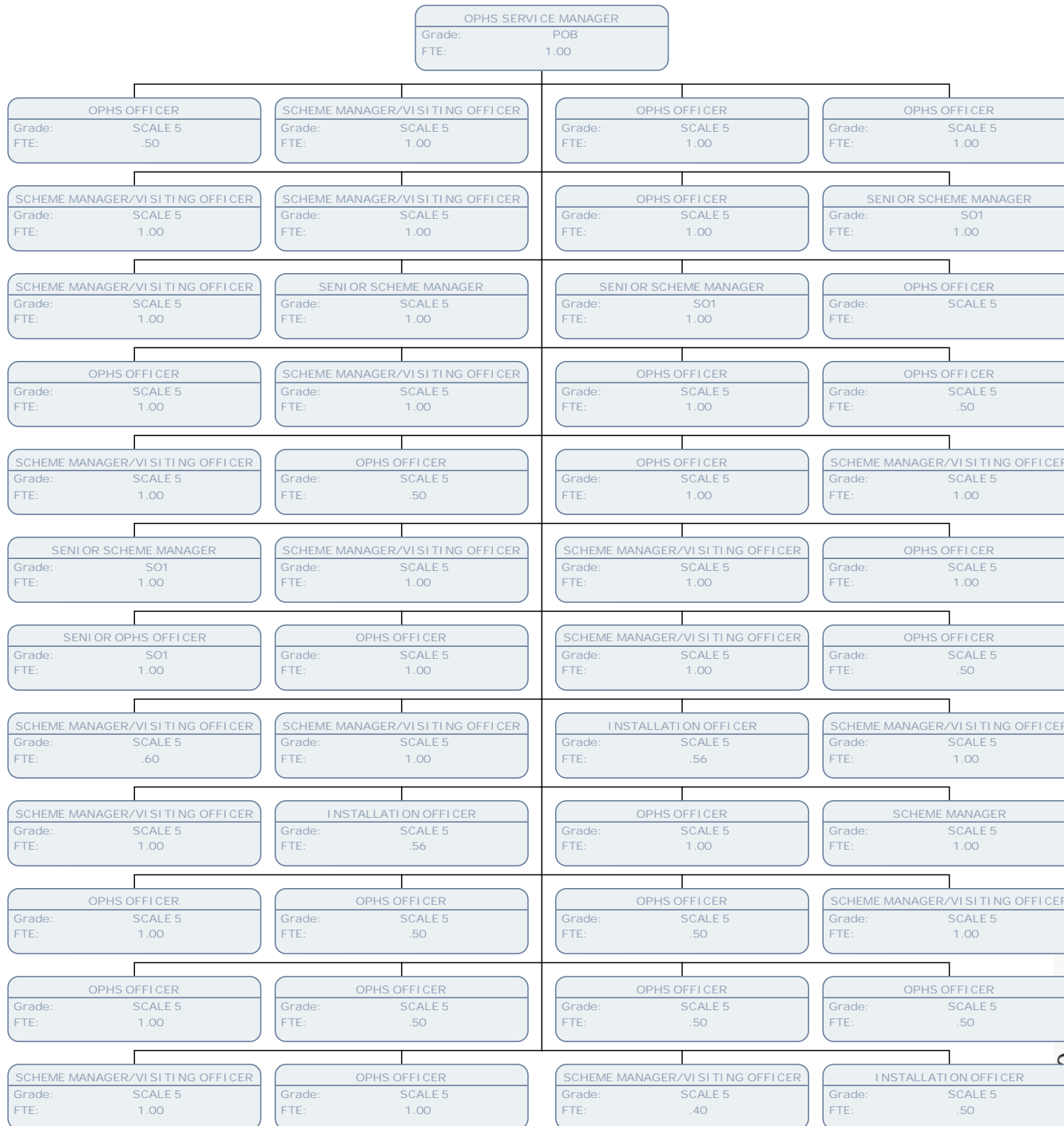

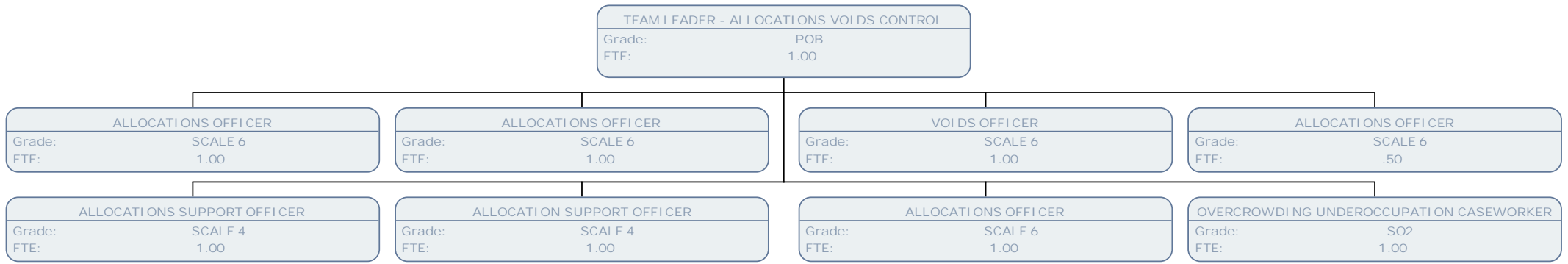

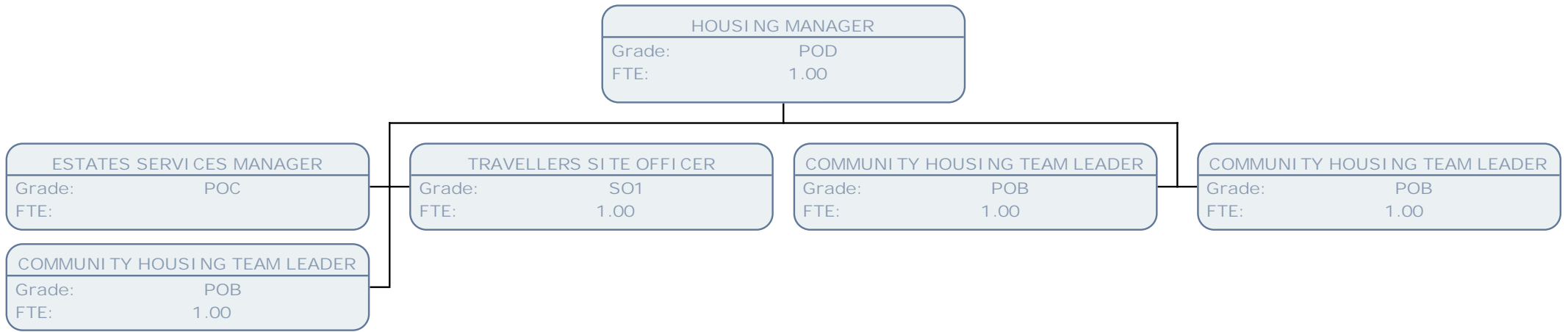

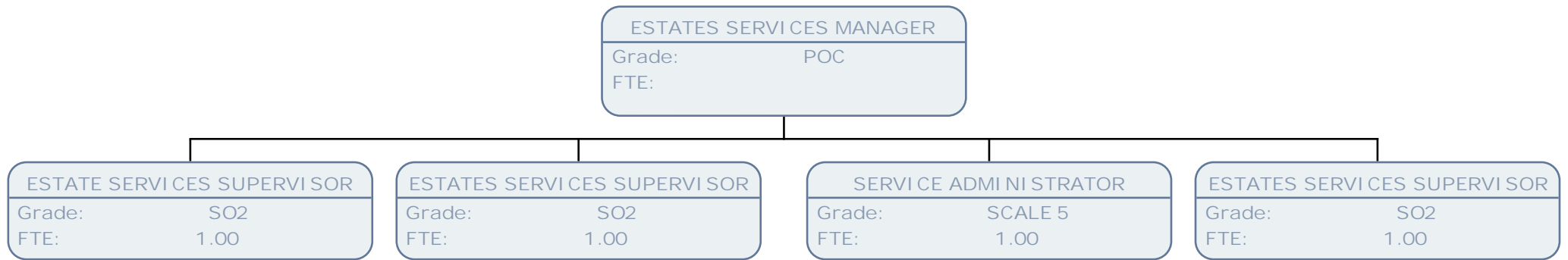

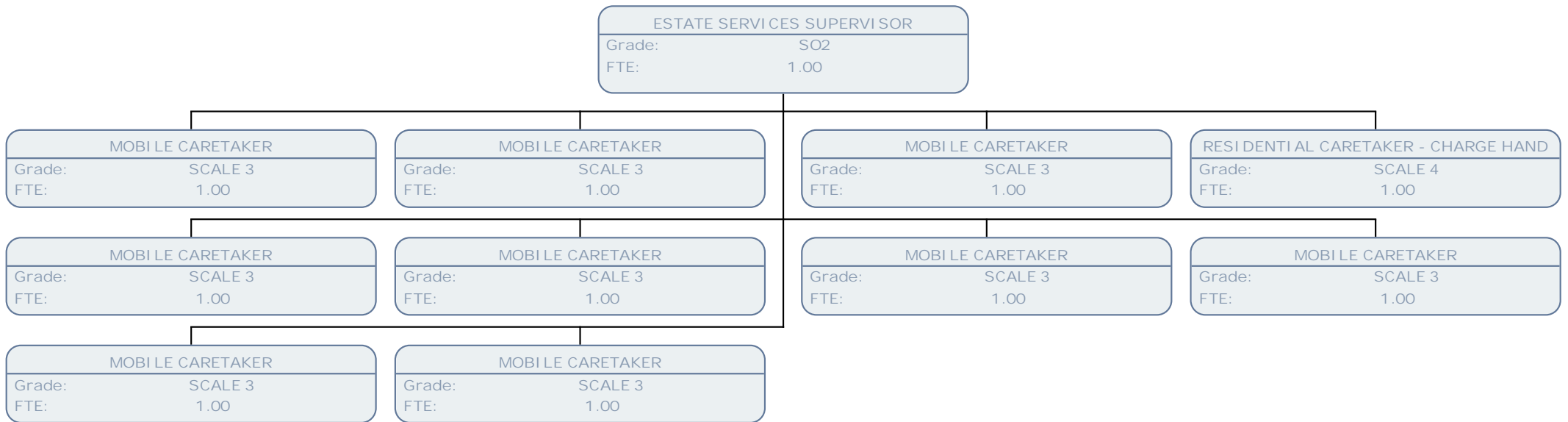

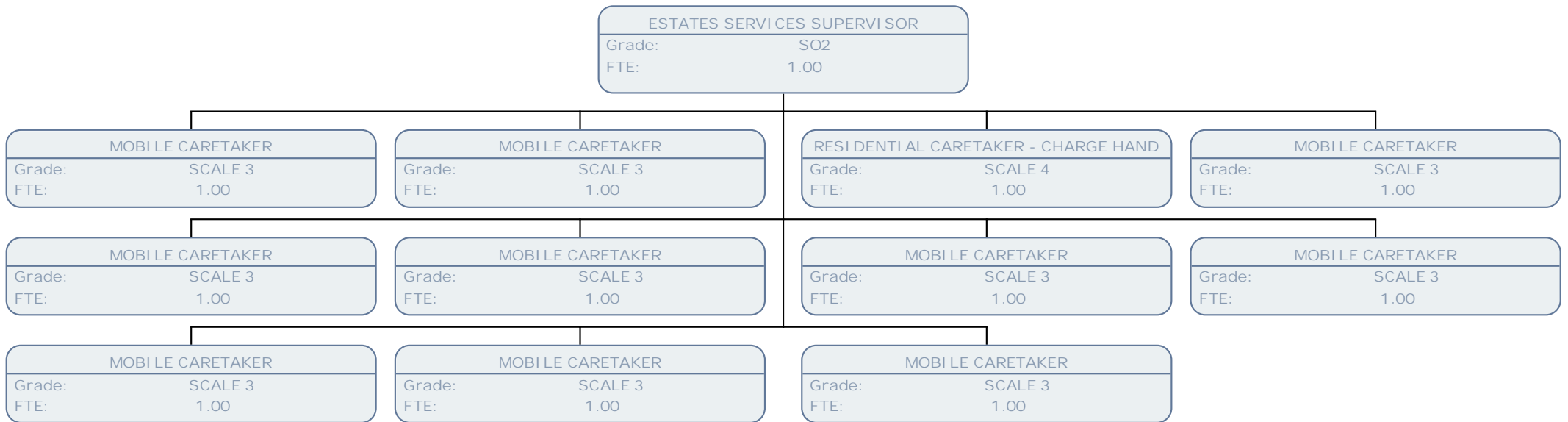

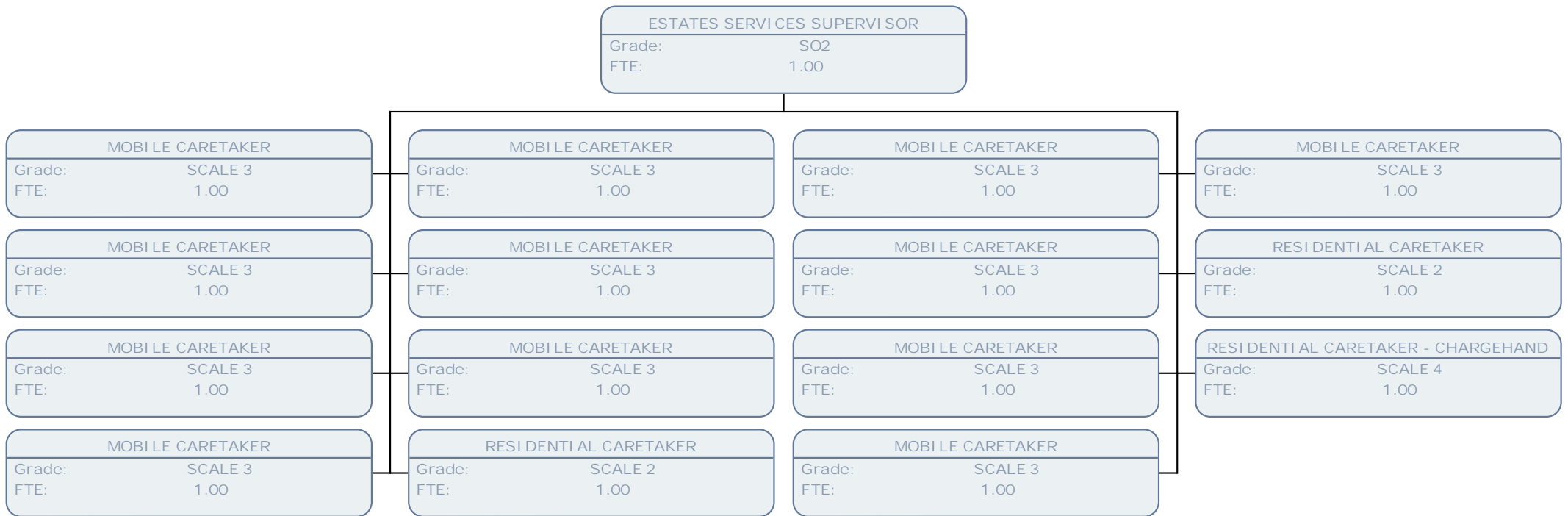

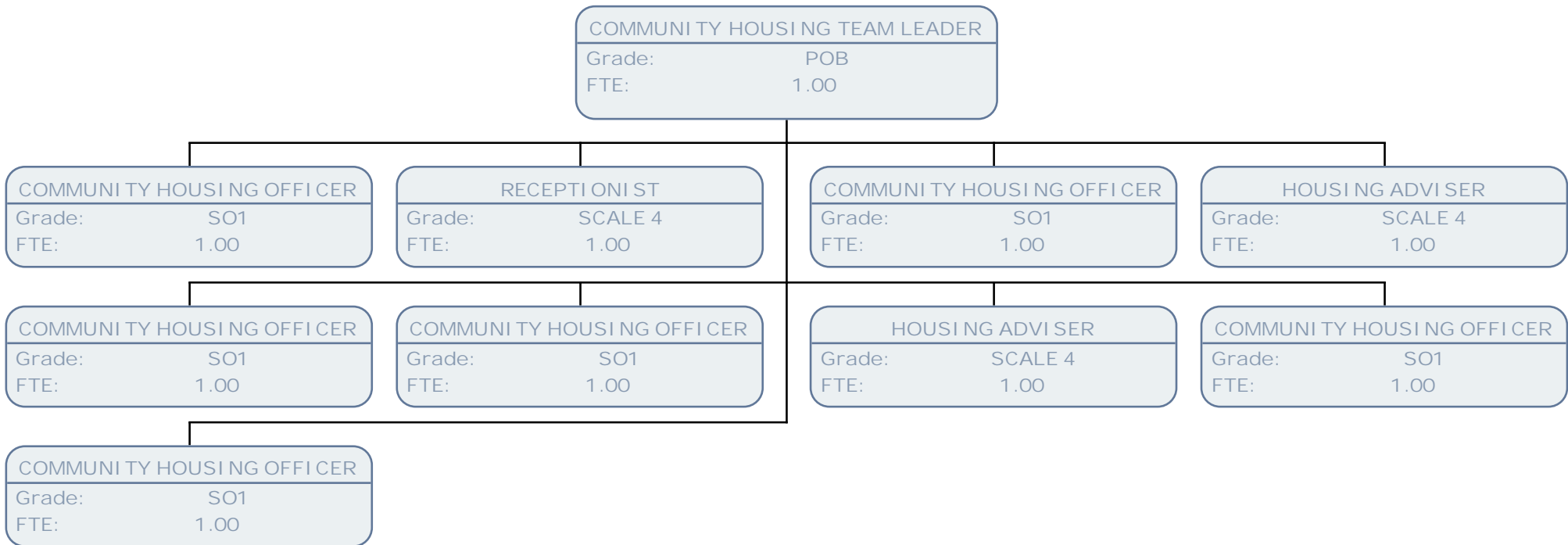

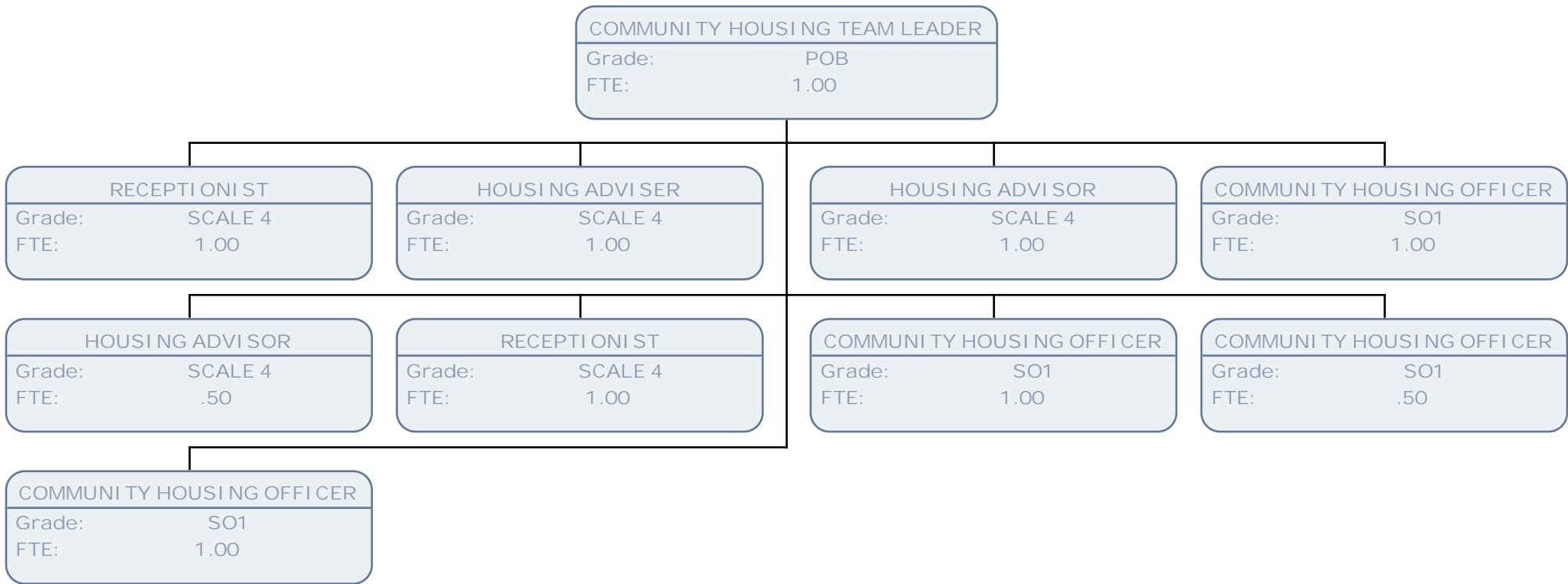

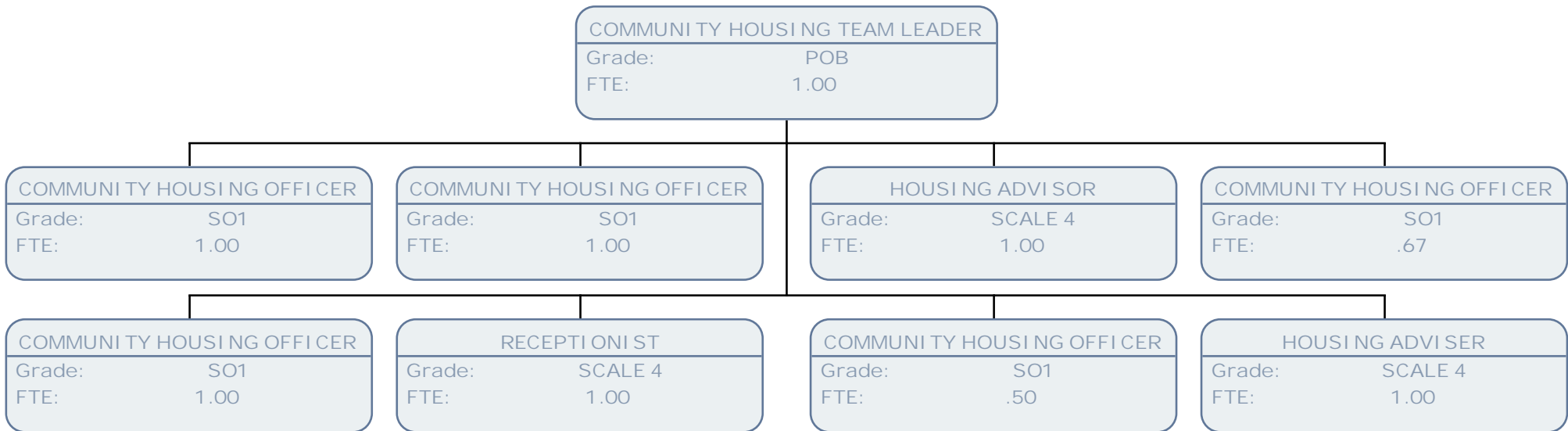

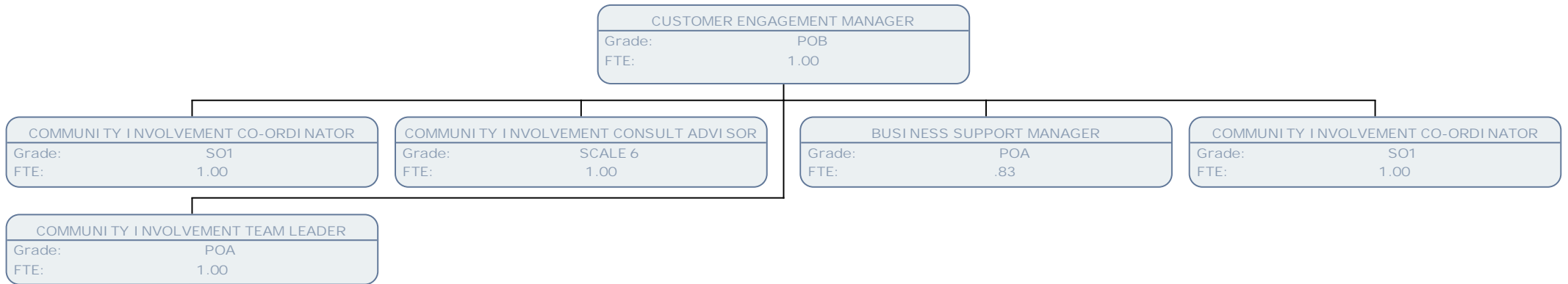

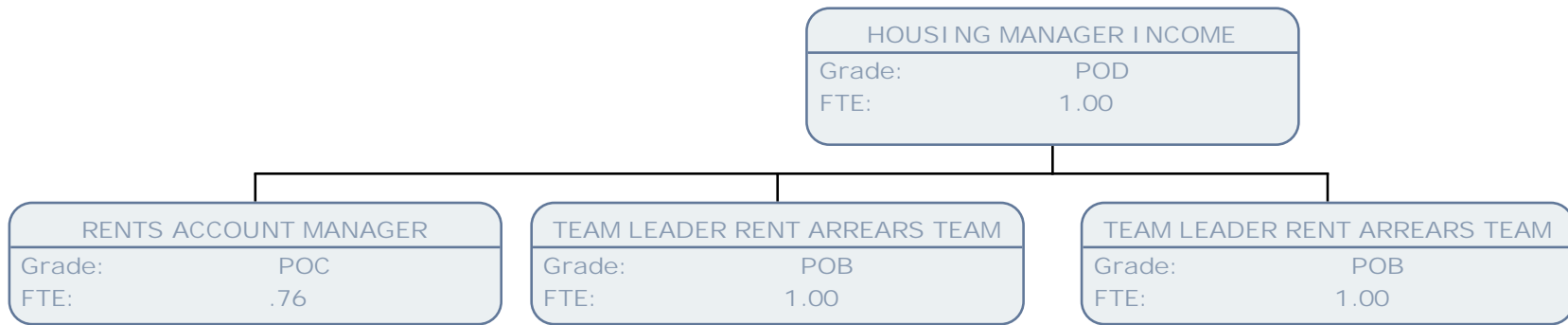

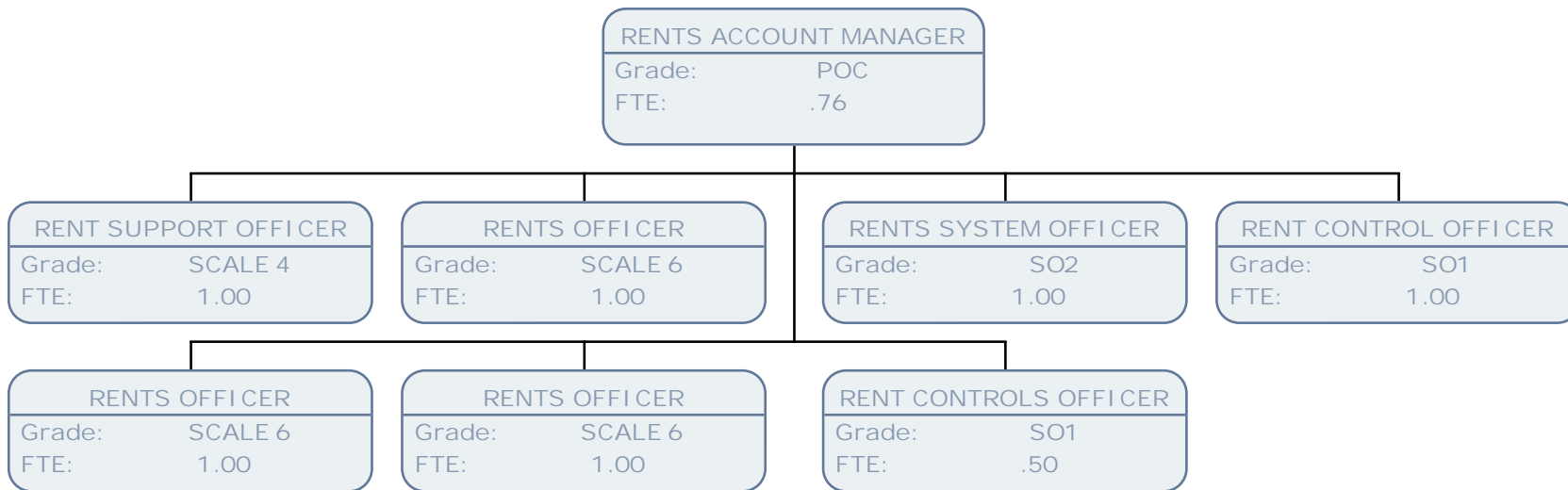

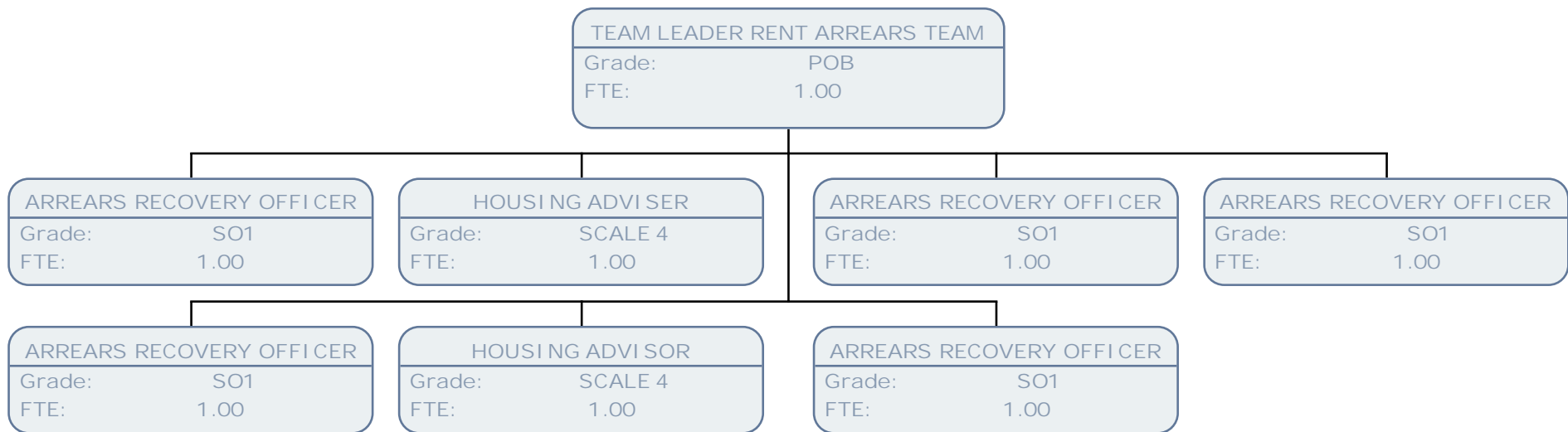

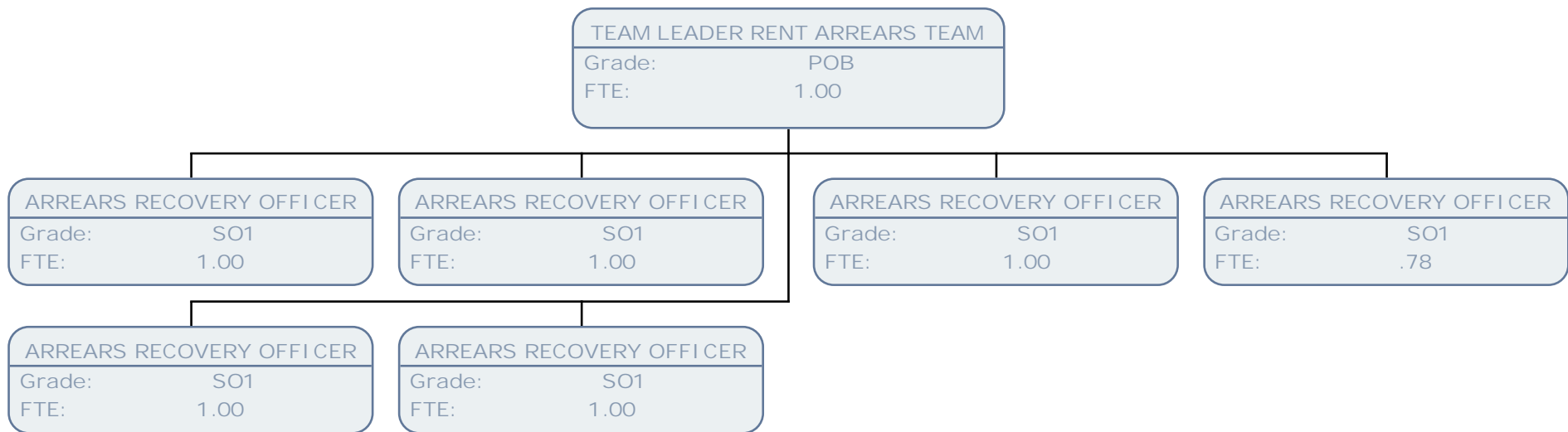

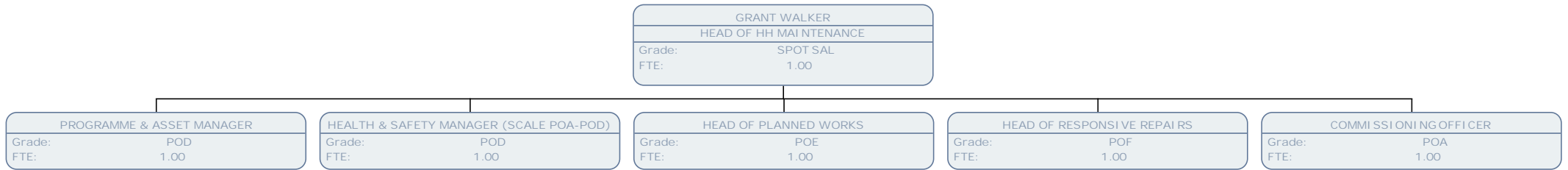

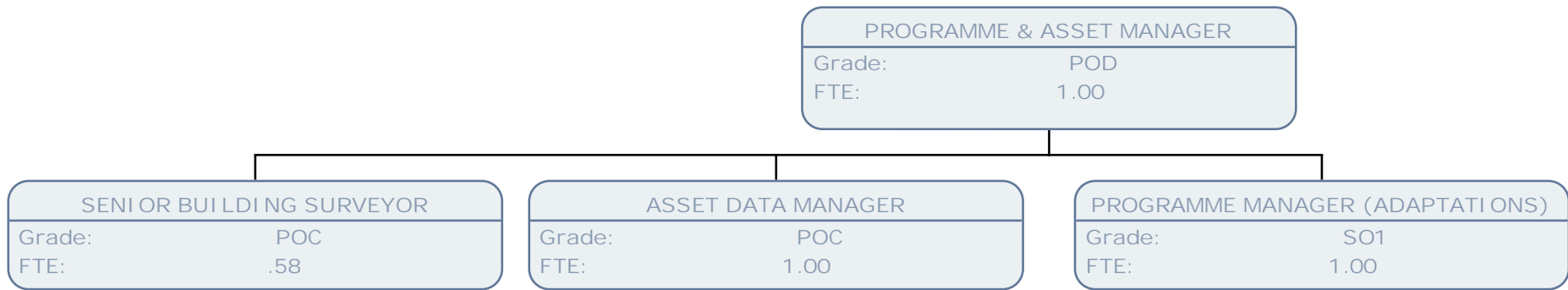

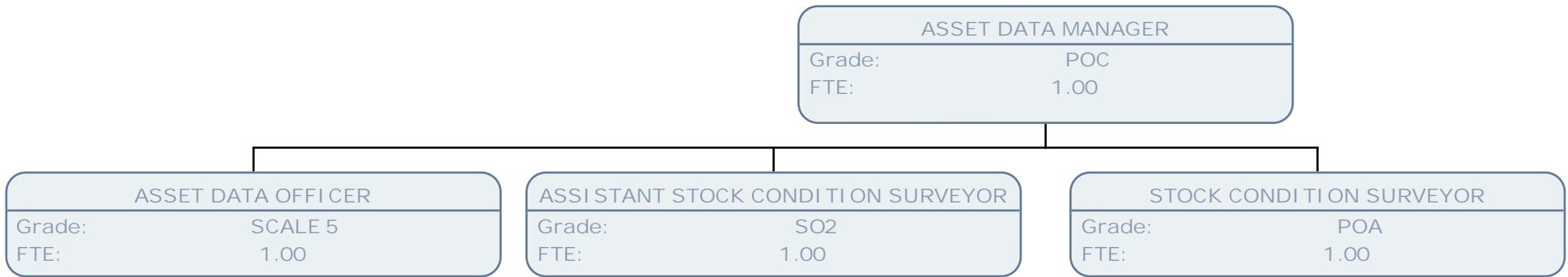

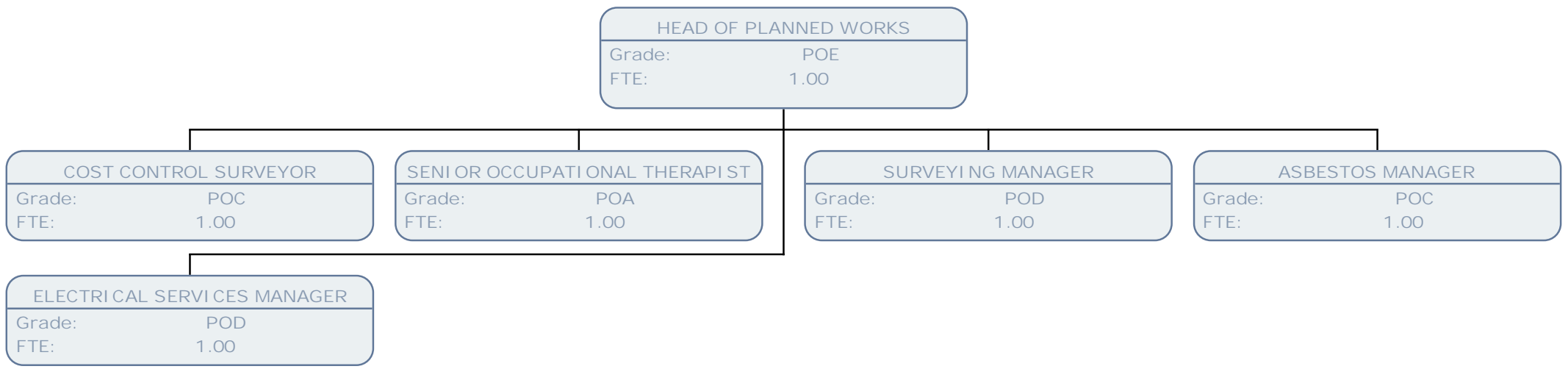

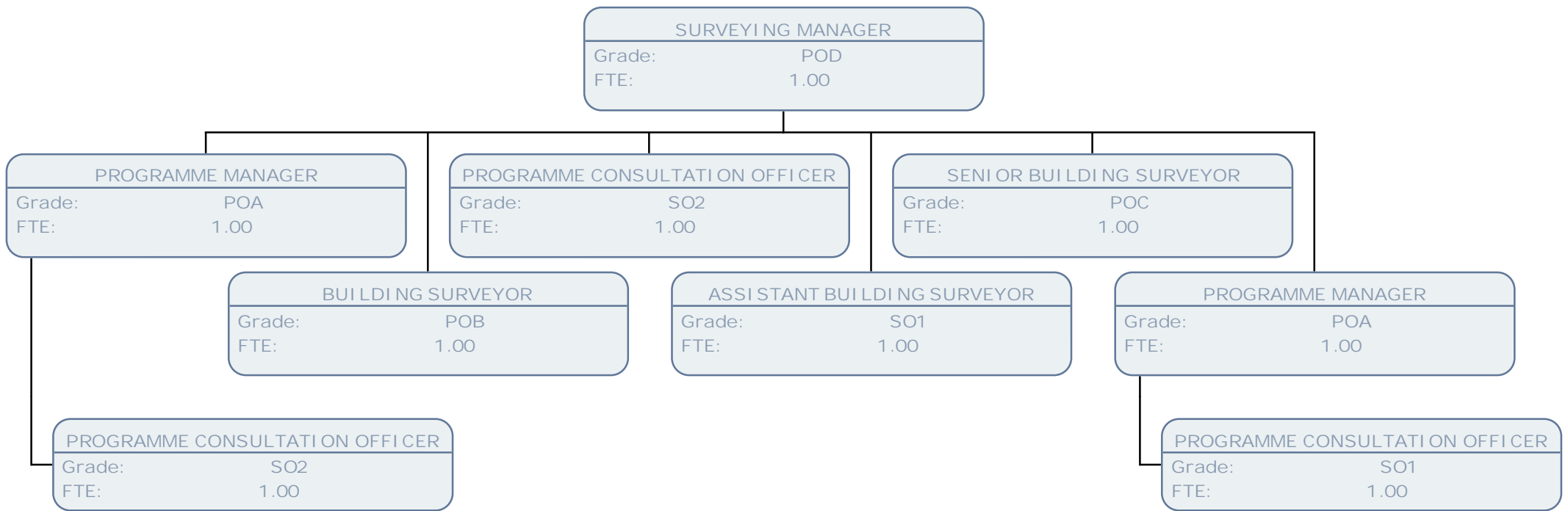

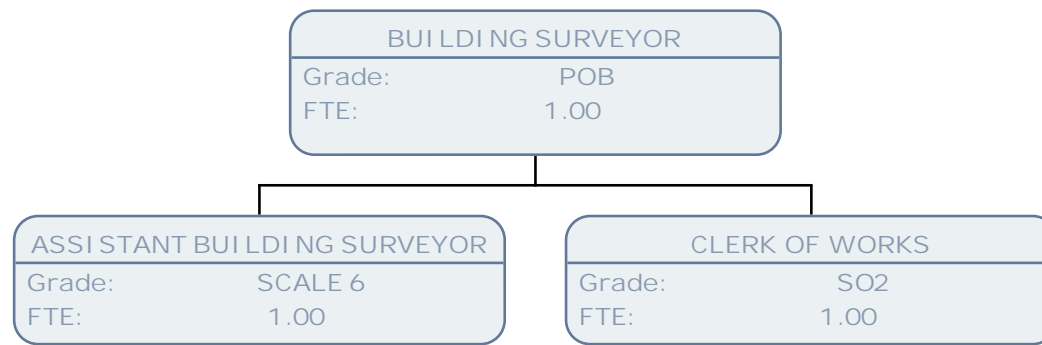

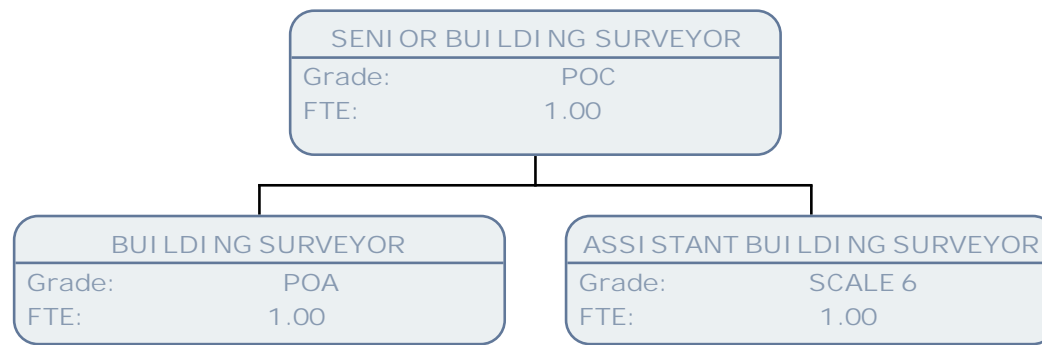

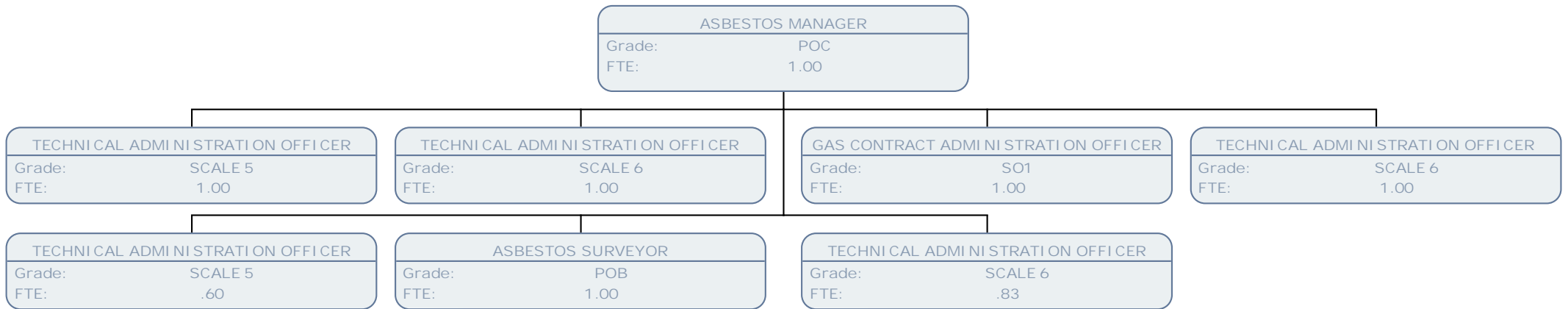

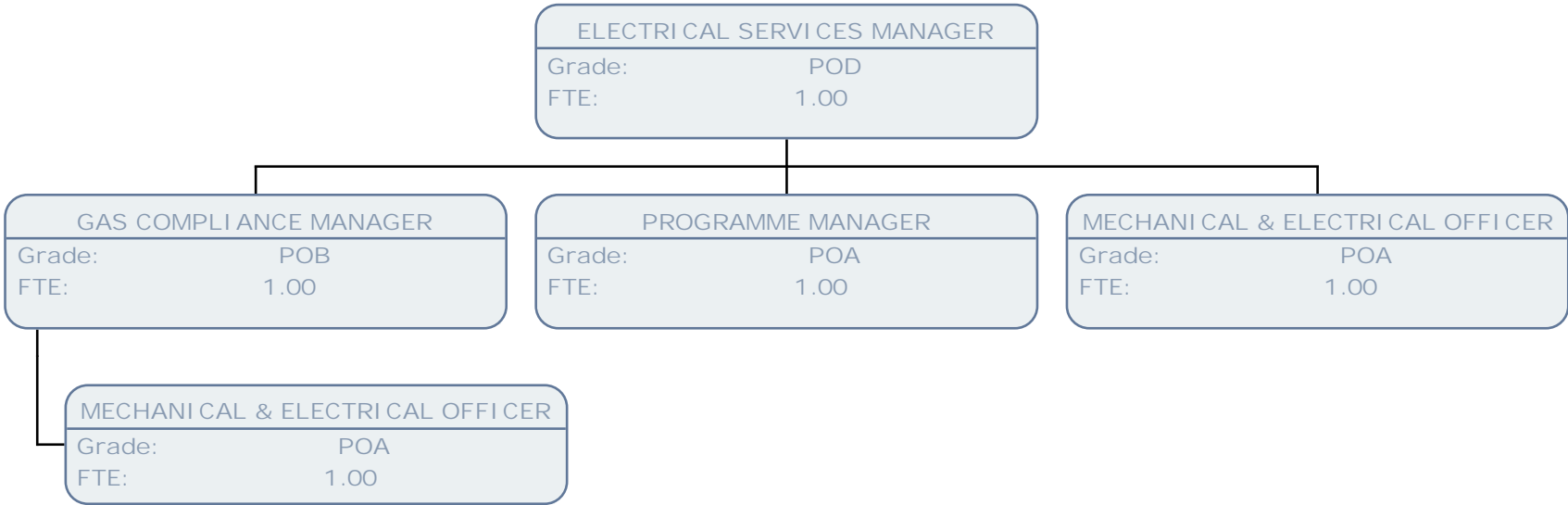

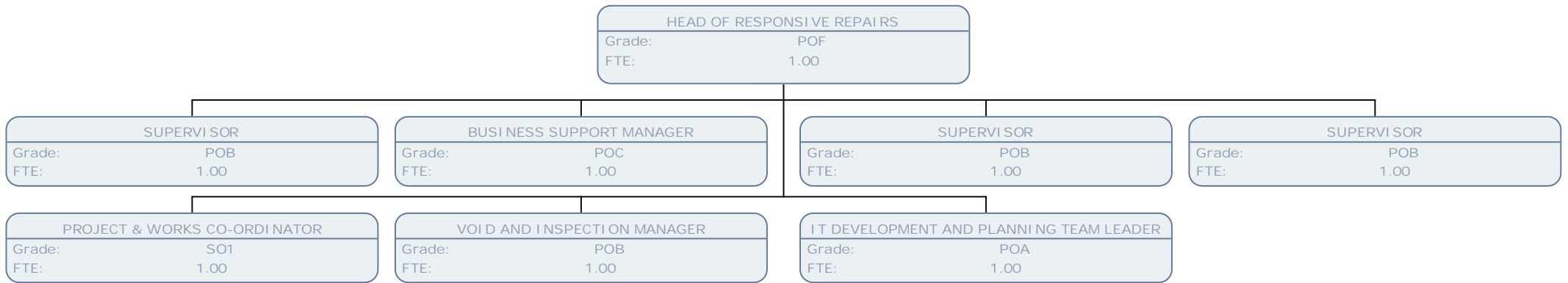

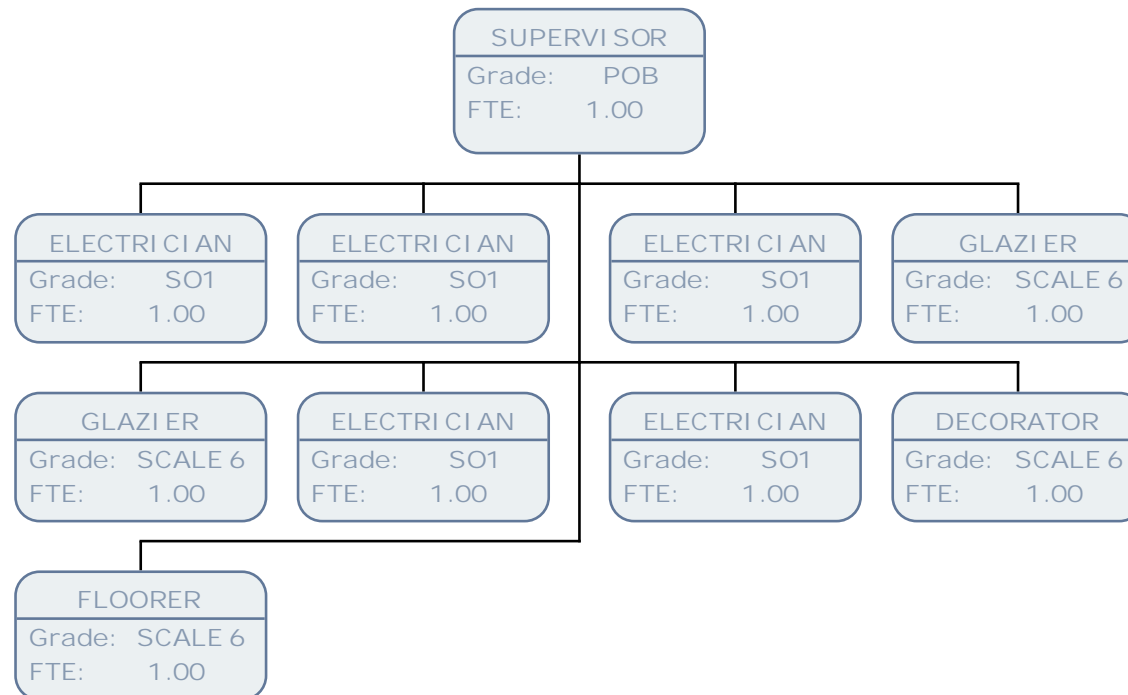

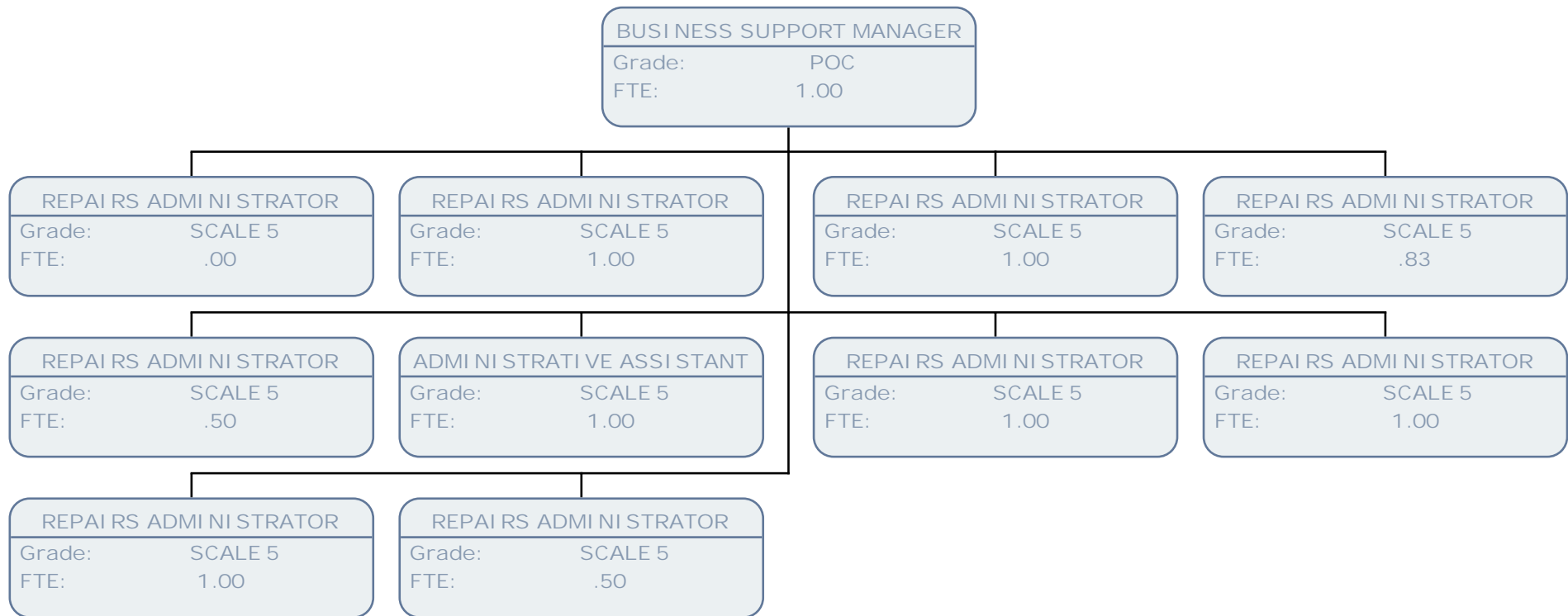

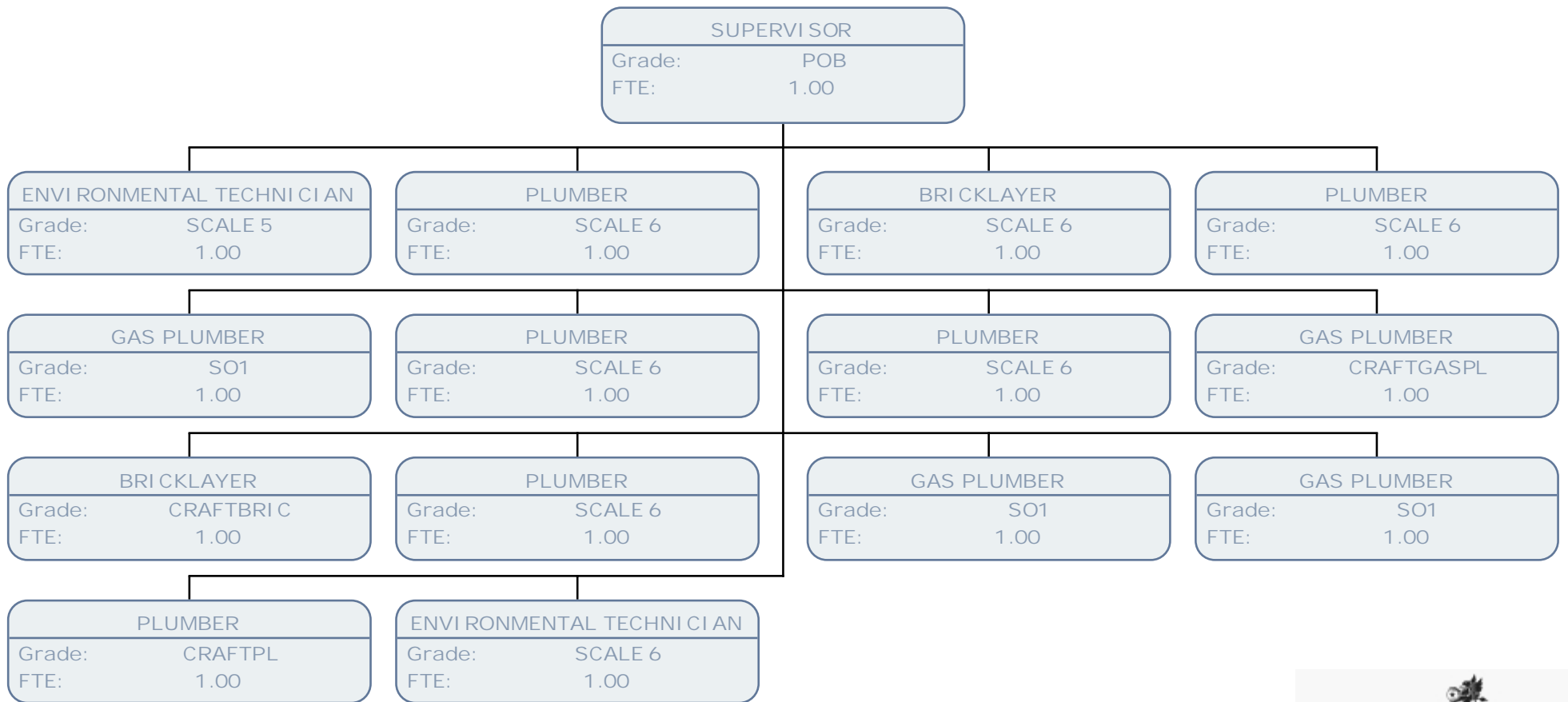

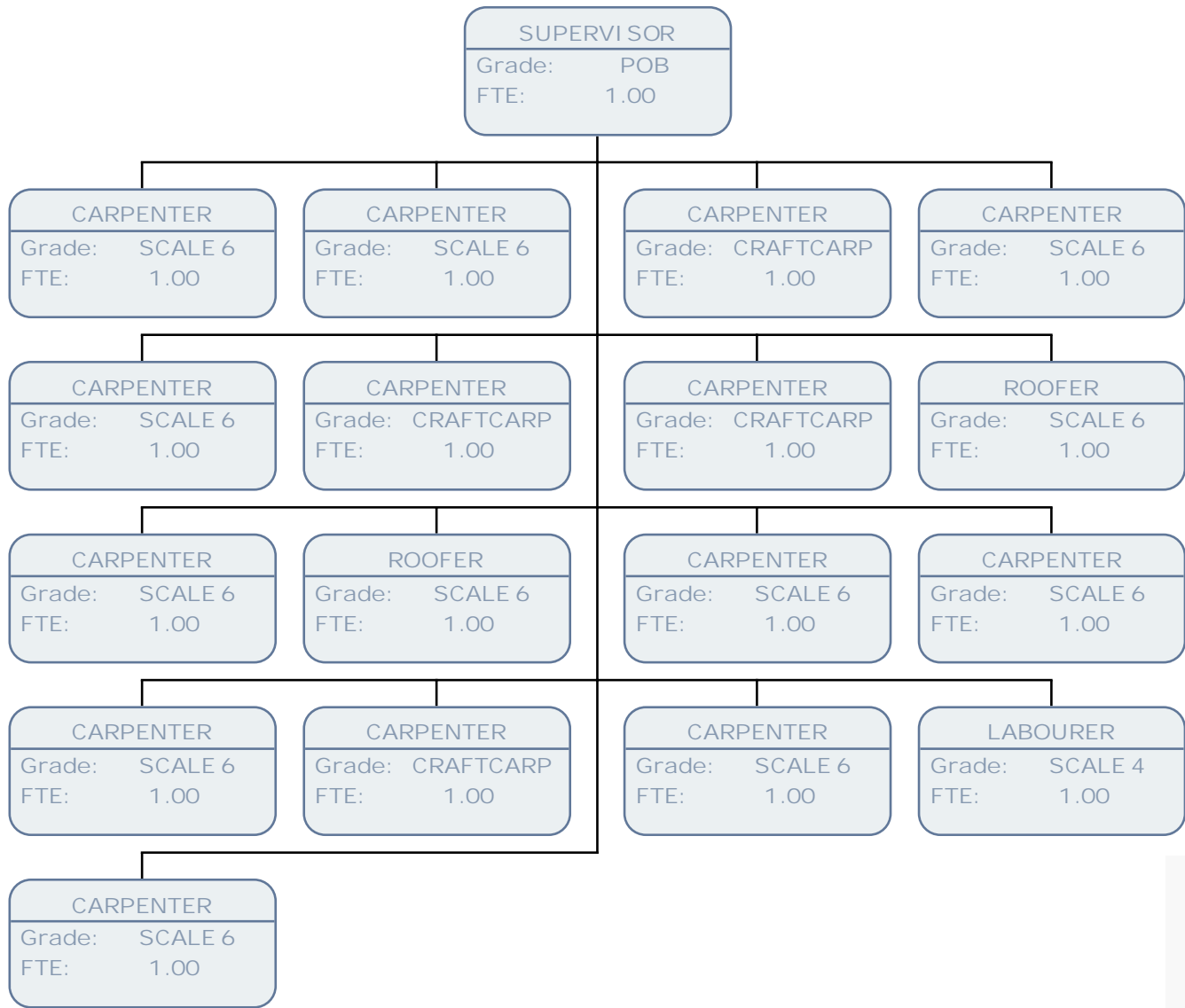

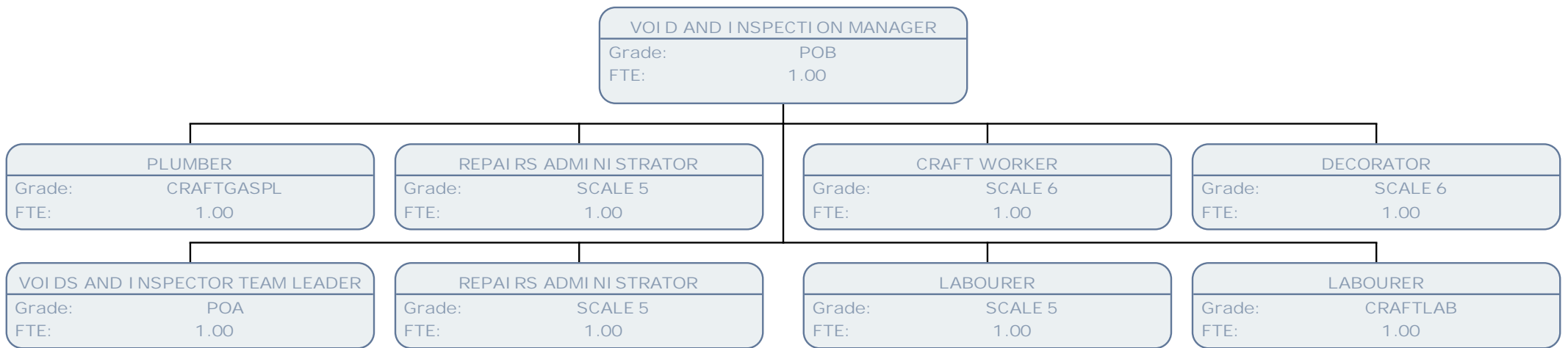

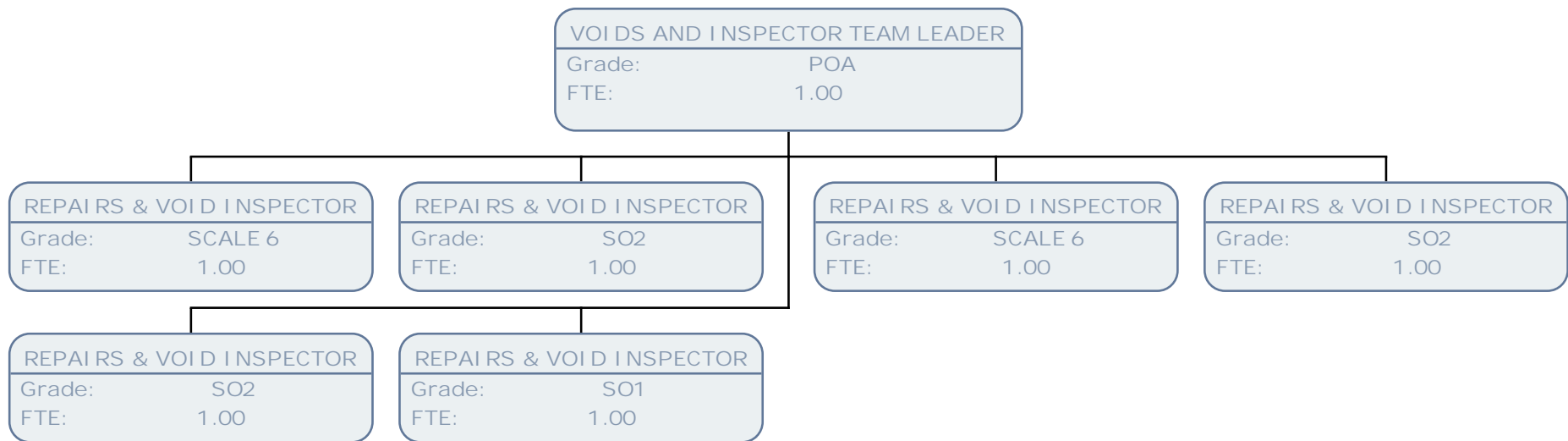

INTERIM HEAD OF TRANSFORMATION
Grade: POD
FTE:

SENIOR TRANSFORMATION OFFICER
Grade: POD
FTE: 1.00

PRACTITIONER - TRANSFORMATION TEAM
Grade: POC
FTE: 1.00



SHARON TOWNSEND	
HEAD OF PERSONALISED SERVICES	
Grade:	JNCCOASTD
FTE:	1.00

SERVICE MANAGER PERSONALISED SRVS ADULTS	
Grade:	POF
FTE:	.83

SERVICE MANAGER PERSONALISED SRV OP	
Grade:	POF
FTE:	1.00



